





**BUREAU
VERITAS**

Test Report No: LD140508N005-R2



Test Report No.:	LD140508N005-R2
Client	
Name :	Shenzhen SOFAR SOLAR Co., Ltd.
Address :	401, Building 4, AnTongDa Industrial Park, District 68, XingDong Community, XinAn Street, BaoAn District, Shenzhen, China.
Test Item :	Solar Grid-tied Inverter
Identification :	SOFAR 1100TL, SOFAR 1600TL, SOFAR 2200TL, SOFAR 2700TL, SOFAR 3000TL
Issued by	
Name :	Bureau Veritas Shenzhen Co., Ltd. Dongguan Branch
Address :	No. 96, Guantai Road (Houjie Section), Houjie Town, Dongguan City, Guangdong Province, 523942, People's Republic of China
Test specification	
Standard :	IEC/EN 62109-1:2010, IEC/EN 62109-2:2011
Test Result :	The sample satisfies to the clauses examined.
CPrepared By :	
	
	<u>2020-04-16</u>
	Date
	_____ Dora Zhang Engineer / Safety Department
Approved By:	
	
	<u>2020-04-16</u>
	Date
	_____ James Huang Technical Manager / Safety Department
<small>This report is governed by, and incorporates by reference, CPS Conditions of Service as posted at the date of issuance of this report at http://www.bureauveritas.com/home/about-us/our-business/cps/about-us/terms-conditions and is intended for your exclusive use. Any copying or replication of this report to or for any other person or entity, or use of our name or trademark, is permitted only with our prior written permission. This report sets forth our findings solely with respect to the test samples identified herein. The results set forth in this report are not indicative or representative of the quality or characteristics of the lot from which a test sample was taken or any similar or identical product unless specifically and expressly noted. Our report includes all of the tests requested by you and the results thereof based upon the information that you provided to us. Measurement uncertainty is only provided upon request for accredited tests. You have 60 days from date of issuance of this report to notify us of any material error or omission caused by our negligence or if you require measurement uncertainty; provided, however, that such notice shall be in writing and shall specifically address the issue you wish to raise. A failure to raise such issue within the prescribed time shall constitute your unqualified acceptance of the completeness of this report, the tests conducted and the correctness of the report contents.</small>	



TEST REPORT

IEC/EN 62109-1:2010, IEC/EN 62109-2:2011

**Safety of power converters for use in photovoltaic power systems –
Part 1: General requirements
Part 2: Particular requirements for inverters**

Report Number	LD140508N005-R2				
Date of issue	2020-04-16				
Total number of pages	98				
Testing laboratory					
Test location	Bureau Veritas Shenzhen Co., Ltd. Dongguan Branch				
Address	No. 96, Guantai Road (Houjie Section), Houjie Town, Dongguan City, Guangdong Province, 523942, People's Republic of China				
Applicant's name	Shenzhen SOFAR SOLAR Co., Ltd.				
Address	401, Building 4, AnTongDa Industrial Park, District 68, XingDong Community, XinAn Street, BaoAn District, Shenzhen, China.				
Test specification:					
Standard	IEC/EN 62109-1:2010 IEC/EN 62109-2:2011				
Non-standard test method	N/A				
Test Report Form No.	TEST REPORT IEC 62109-2 VER.5				
Test Report Form(s) Originator	Bureau Veritas Shenzhen Co., Ltd. Dongguan Branch				
Master TRF	Dated 2016-08				
Test item description	Solar Grid-tied inverter				
Trade Mark					
Manufacturer	Shenzhen SOFAR SOLAR Co., Ltd.				
Model/Type reference	SOFAR 1100TL, SOFAR 1600TL, SOFAR 2200TL, SOFAR 2700TL, SOFAR 3000TL				
Ratings	SOFAR 1100TL	SOFAR 1600TL	SOFAR 2200TL	SOFAR 2700TL	SOFAR 3000TL
MPP DC voltage range [V]	110-380	165-380	170-450	210-450	230-450
Input DC voltage range [V]	90-400, max. 450		100-480, max. 500		
Input DC current [A]	Max.10		Max.13		
Output AC voltage [V]	230V, 50/60Hz				
Output AC current [A]	Max.4.5	Max.7.0	Max.9.5	Max.11.5	Max.13.0
Output power [W]	1000	1500	2000	2500	2800



Copy of marking plate (representative)

SOFAR SOLAR	
PV Grid Inverter	SOFAR 1100TL
Maximum DC input voltage	450V
DC voltage range	90-400V
Maximum DC input current	10A
Maximum PV Isc	12A
Nominal Grid voltage	L/N/PE 230V~
Maximum AC output current	4.5A
Nominal Grid frequency	50Hz
Maximum AC output power	1000W
Power factor	1
Ingress protection	IP65
Operating temperature range	-25-+60°C
Protective class	Class I
Manufacturer: Shenzhen SOFARSOLAR Co., Ltd. Made in China	
VDE0126-1-1, VDE-AR-N 4105, G83/2, EN50438, C10/11, AS4777, RD1699, UTE C15-7-12-1	

SOFAR SOLAR	
PV Grid Inverter	SOFAR 1600TL
Maximum DC input voltage	450V
DC voltage range	90-400V
Maximum DC input current	10A
Maximum PV Isc	12A
Nominal Grid voltage	L/N/PE 230V~
Maximum AC output current	7A
Nominal Grid frequency	50Hz
Maximum AC output power	1500W
Power factor	1
Ingress protection	IP65
Operating temperature range	-25-+60°C
Protective class	Class I
Manufacturer: Shenzhen SOFARSOLAR Co., Ltd. Made in China	
VDE0126-1-1, VDE-AR-N 4105, G83/2, EN50438, C10/11, AS4777, RD1699, UTE C15-7-12-1	

SOFAR SOLAR	
PV Grid Inverter	SOFAR 2200TL
Maximum DC input voltage	500V
DC voltage range	100-480V
Maximum DC input current	13A
Maximum PV Isc	15A
Nominal Grid voltage	L/N/PE 230V~
Maximum AC output current	9.5A
Nominal Grid frequency	50Hz
Maximum AC output power	2000W
Power factor	1
Ingress protection	IP65
Operating temperature range	-25-+60°C
Protective class	Class I
Manufacturer: Shenzhen SOFARSOLAR Co., Ltd. Made in China	
VDE0126-1-1, VDE-AR-N 4105, G83/2, EN50438, C10/11, AS4777, RD1699, UTE C15-7-12-1	

SOFAR SOLAR	
PV Grid Inverter	SOFAR 2700TL
Maximum DC input voltage	500V
DC voltage range	100-480V
Maximum DC input current	13A
Maximum PV Isc	15A
Nominal Grid voltage	L/N/PE 230V~
Maximum AC output current	11.5A
Nominal Grid frequency	50Hz
Maximum AC output power	2500W
Power factor	1
Ingress protection	IP65
Operating temperature range	-25-+60°C
Protective class	Class I
Manufacturer: Shenzhen SOFARSOLAR Co., Ltd. Made in China	
VDE0126-1-1, VDE-AR-N 4105, G83/2, EN50438, C10/11, AS4777, RD1699, UTE C15-7-12-1	

SOFAR SOLAR	
PV Grid Inverter	SOFAR 3000TL
Maximum DC input voltage	500V
DC voltage range	100-480V
Maximum DC input current	13A
Maximum PV Isc	15A
Nominal Grid voltage	L/N/PE 230V~
Maximum AC output current	13A
Nominal Grid frequency	50Hz
Maximum AC output power	2800W
Power factor	1
Ingress protection	IP65
Operating temperature range	-25-+60°C
Protective class	Class I
Manufacturer: Shenzhen SOFARSOLAR Co., Ltd. Made in China	
VDE0126-1-1, VDE-AR-N 4105, G83/2, EN50438, C10/11, AS4777, RD1699, UTE C15-7-12-1	



General remarks:

The test results presented in this report relate only to the object tested.
This report shall not be reproduced, except in full, without the written approval of the Issuing testing laboratory.

"(See Enclosure #)" refers to additional information appended to the report.

"(See appended table)" refers to a table appended to the report.

Report history:

Remark 1	This test report is to replace the original test report. LD140508N0005-R1.
Remark 2	The modifications applied on this report is <ul style="list-style-type: none"> - Update the applicant's address. - Update the factory name and address. - Update the list of critical components, add DC switch information.
Remark 3	For the above "Remark 2" described changes, no test were considered necessary.

Throughout this report a comma / point is used as the decimal separator.

Name and address of factory (ies)	Dongguan SOFAR SOLAR Co.,Ltd. 1F - 6F, Building E, No. 1 JinQi Road, Bihu Industrial Park, Wulian Village, Fenggang Town, Dongguan City
--	---

General product information:

The Solar Inverter converts DC voltage into AC voltage.

The input and output are protected by varistors to Earth. The unit is providing EMC filtering at the PV input and output toward mains. The unit does not provide galvanic separation from input to output (transformerless). The output is switched off redundantly by the high power switching bridge and two relays. This assures that the opening of the output circuit will also operate in case of a single error.

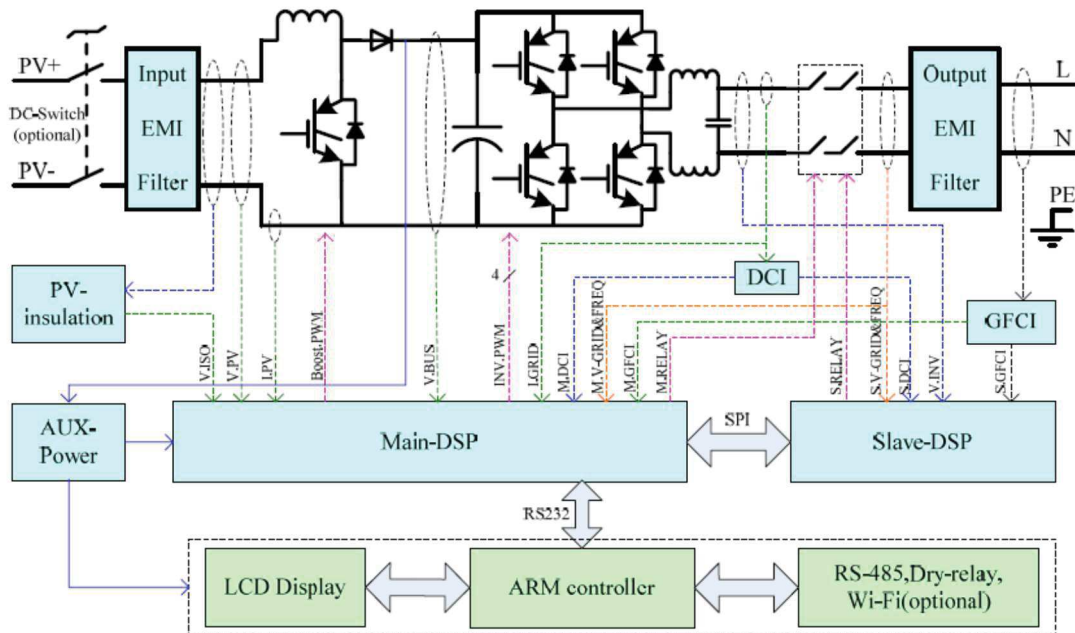

Figure 1 Block diagram

The internal control is redundant built. It consists of Microcontroller Master DSP (UC34) and Slave DSP (UC35).

The Master DSP control the relays (RYP2-RYP5) by switching signals; measures the PV voltage, PV current, Bus voltage, grid voltage, frequency, AC current with injected DC and the array insulation resistance to ground. In addition it tests the current sensors and the RCMU circuit before each start up.

The Slave DSP (UC35) is measures the grid voltage, AC current, grid frequency and residual current, also can switch off the relays (RYP2-RYP5) independently, and communicate with Master DSP (UC34) each other.

The current is measured by a current sensor. The AC current signal and the injected DC current signal are sent to the Master DSP (UC34). The Master DSP (UC34) tests and calibrates before each start up all current sensors.

The unit provides two relays in series in all output conductors. When single fault applied to one relay, alarm an error code in display panel, another redundant relay provides basic insulation maintained between the PV array and the mains. All the relays are tested before each start up.

The product was tested on:
Hardware version: V1.00
Software version: V3.20



Description of the differences of the models within a series:

The models SOFAR 1100TL, SOFAR 1600TL, SOFAR 2200TL, SOFAR 2700TL and SOFAR 3000TL are same as in hardware except the components are in the difference table. Identical in software the output power just adjusted by software.

Difference table					
	SOFAR 1100TL	SOFAR 1600TL	SOFAR 2200TL	SOFAR 2700TL	SOFAR 3000TL
Boost inductor	2,6mH	2,6mH	1,9mH	1,9mH	1,9mH
Resistor (RP105, RP108 /RP189,RP109)	220ohm / 10Kohm	220ohm / 10Kohm	200ohm / 7,5Kohm	200ohm / 7,5Kohm	200ohm / 7,5Kohm
BUS capacitor (ECP1, ECP3, ECP4)	2 pcs	2 pcs	3 pcs	3 pcs	3 pcs
Inverter inductor	3,4mH	2,3mH	2,1mH	1,5mH	1,3mH
Resistor (RP118, RP119, RC18 /RP120, RP121,RC22)	499 Ω, 200 Ω, 200 Ω	1 KΩ, 200 Ω, 100 Ω	1 KΩ, 330 Ω, 330 Ω	2 KΩ, 100 Ω, 100 Ω	2 KΩ, 100 Ω, 100 Ω

DC switch and Wi-Fi module are optional.

Test condition:

Temperature: 25°C

Relative humidity: 70%

Air pressure: 1002 mbar



This testreport includes the following Appendixes:

Appendix No.	Description	Page(s)
1	4.8.2 TABLE: Array insulation resistance detection for inverters for ungrounded and functionally grounded arrays (page 87).	1
2	4.8.3 Array residual current detection test result (page 88-91).	4



IEC/EN 62109-1, IEC/EN 62109-2			
Clause	Requirement – Test	Result – Remark	Verdict
4	GENERAL TESTING REQUIREMENTS		P
4.1	General		P
4.2	General conditions for testing	See appended table.	P
4.3	Thermal testing	See appended table.	P
4.3.1	General		P
4.3.2	Maximum temperatures	See appended table.	P
4.3.2.1	General		P
4.3.2.2	Touch temperatures		P
	In order to limit the touch temperatures of accessible parts of PCE, the maximum temperature for accessible parts of the PCE shall be in compliance with Table 3.	Considered.	P
	It is permitted that accessible parts that are required to get hot as part of their intended function (for example heatsinks) may have temperatures up to 100 °C, if the parts are marked with the hot surface marking of symbol 14 of Annex C. For products only for use in a closed electrical operating area the 100 °C limit does not apply.	Considered.	P
	These limits are in addition to the applicable limits in 4.3.2.1.	Considered.	P
4.3.2.3	Temperature limits for mounting surfaces		P
	In order to protect against long-term degradation of building materials, surfaces of the PCE that will be in contact with the mounting surface shall not exceed a maximum total temperature of 90 °C. This limit is in addition to the applicable limits in 4.3.2.1 and 4.3.2.2. Compliance is checked by the testing in 4.3.2.1 with the PCE mounted according to the manufacturer's instructions, on a softwood surface.	Considered.	P
4.4	Testing in single fault condition	See appended table.	P
4.4.1	General		P
4.4.2	Test conditions and duration for testing under fault conditions	Considered.	P
4.4.2.1	General		P
4.4.2.2	Duration of tests	Considered.	P
4.4.3	Pass/fail criteria for testing under fault conditions		P
4.4.3.1	Protection against shock hazard	No shock hazard.	P
4.4.3.2	Protection against the spread of fire	No spread of fire.	P
4.4.3.3	Protection against other hazards	No other hazards.	P
4.4.3.4	Protection against parts expulsion hazards	No expulsion hazard.	P
4.4.4	Single fault conditions to be applied	Considered.	P
4.4.4.1	Component fault tests	See appended table.	P
4.4.4.2	Equipment or parts for short-term or intermittent operation	Continue-operation.	N/A
	Components such as motors, relays, other electromagnetic devices and heaters, which are normally operated only intermittently, shall be operated continuously if continuous operation could occur in a single fault condition.		N/A
4.4.4.3	Motors		N/A
4.4.4.4	Transformer short circuit tests	See appended table.	P



IEC/EN 62109-1, IEC/EN 62109-2			
Clause	Requirement – Test	Result – Remark	Verdict
4.4.4.5	Output short circuit	See appended table.	P
4.4.4.6	Backfeed current test for equipment with more than one source of supply	Considered.	P
	For equipment intended to be connected simultaneously to more than one source of supply, each input of the PCE shall be tested one at a time, to determine if hazardous conditions can result from current from one source of supply flowing into the wiring for another source under fault conditions.	Considered.	P
	With the PCE operating under normal conditions, a short circuit shall be applied at the field wiring terminals of the circuit under consideration, with all intended other sources connected to the PCE through the overcurrent protective devices (if any) intended to be present in the installation.	Considered.	P
	In addition to the requirements of 4.4.3, the short-circuit currents are to be recorded and if they exceed the maximum rated current for the port, the maximum measured current shall be provided in the installation manual for the purpose of coordination of overcurrent protection of the external circuit conductors (see 5.3.2).		N/A
4.4.4.7	Output overload	Considered.	P
4.4.4.8	Cooling system failure		N/A
	Equipment cooling shall be faulted as follows, one fault at a time:	See below.	N/A
	a) air-intakes shall be blocked or partially blocked;	Considered.	N/A
	b) cooling fans shall be stopped or disconnected, one at a time;	Considered.	N/A
	c) cooling by circulation of water or other coolant shall be stopped or partially restricted.	No such coolant circulation devices.	N/A
4.4.4.9	Heating devices	No heating devices.	N/A
	In equipment incorporating heating devices, the following faults shall be applied one at a time:		N/A
	a) timers which limit the heating period shall be overridden to energize the heating circuit continuously;		N/A
	b) temperature control devices or circuits shall have single fault conditions applied such that control over the heater is lost. Over-temperature protection devices meeting the requirements of 14.3 are left operational during the test.		N/A
4.4.4.10	Safety interlock systems	No such systems.	N/A
4.4.4.11	Reverse d.c. connections	Considered.	N/A
	Unless the means of connection prevents reversal, external d.c. connections shall be connected with reverse polarity.		N/A
4.4.4.12	Voltage selector mismatch	No such devices.	N/A
	Equipment employing a voltage selector intended to be adjusted or set to match the supply voltage, is to have its voltage selector set in any position with the equipment connected to any of its rated supply circuits.		N/A



IEC/EN 62109-1, IEC/EN 62109-2			
Clause	Requirement – Test	Result – Remark	Verdict
4.4.4.13	Mis-wiring with incorrect phase sequence or polarity	No any hazard occurred.	P
	If connection to the a.c. supply with incorrect phase sequence or incorrect polarity of an earthed single-phase supply could result in a hazard, a mis-wiring test shall be applied.		P
4.4.4.14	Printed wiring board short-circuit test	See appended table.	P
	Where permitted by 7.3.7.7, functional insulation on PWBs, provided by spacings that are less than those specified in Table 7 and Table 8 (see 7.3.7.7) shall be type tested as described below.		P
	Each location of decreased spacings shall be short-circuited one at a time, and the shortcircuit shall be maintained until no further damage occurs. Overcurrent protection integral to the PCE, or required to be used with the PCE, is allowed to open. During and after each test, the PCE shall comply with the requirements of 4.4.3.		P
4.4.4.15 of IEC 62109-2	Fault-tolerance of protection for grid-interactive inverters	See below.	P
4.4.4.15.1 of IEC 62109-2	Fault-tolerance of residual current monitoring according to 4.8.3.5: the residual current monitoring system operates properly	See appended table.	P
	a) .- The inverter ceases to operate	See appended table.	P
	- Indicates a fault in accordance with §13.9		P
	- Disconnect from the mains		P
	- not re-connect after any sequence of removing and reconnecting PV power		P
	- not re-connect after any sequence of removing and reconnecting AC power		P
	- not re-connect after any sequence of removing and reconnecting both PV and AC power		P
	b) .- The inverter continues to operate	The inverter ceases to operate.	N/A
	- the residual current monitoring system operates properly under single fault condition		N/A
	- Indicates a fault in accordance with §13.9		N/A
	c)..- The inverter continues to operate regardless of loss of residual current monitoring functionality		N/A
	- not re-connect after any sequence of removing and reconnecting PV power		N/A
	- not re-connect after any sequence of removing and reconnecting AC power		N/A
	- not re-connect after any sequence of removing and reconnecting both PV and AC power		N/A
	- Indicates a fault in accordance with §13.9		N/A
4.4.4.15.2 of IEC 62109-2	Fault-tolerance of automatic disconnecting means	Two series relay in each line and may independent operation for each relay.	P



IEC/EN 62109-1, IEC/EN 62109-2			
Clause	Requirement – Test	Result – Remark	Verdict
4.4.4.15.2.1 of IEC 62109-2	General		P
	The means provided for automatic disconnection of a grid-interactive inverter from the mains shall:		P
	- disconnect all grounded current-carrying conductors from the mains	Disconnected all line conductors from the mains.	P
	- disconnect all ungrounded current-carrying conductors from the mains		P
	- be such that with a single fault applied to the disconnection means or to any other location in the inverter, at least basic insulation or simple separation is maintained between the PV array and the mains when the disconnecting means is intended to be in the open state.	The least basic insulation is maintained between the PV array and the mains when the relay on the open state.	P
4.4.4.15.2.2 of IEC 62109-2	Design of insulation or separation complies with requirements of 7.3.7 of Part 1: report here Part 1 comment and verdict.	Considered.	P
4.4.4.15.2.3 of IEC 62109-2	For non-isolated inverter, automatic checking of the isolation provided by a disconnect means after single fault.	The inverter automatic checking of the isolation after single fault occurred.	P
	If the check fail:		P
	- any still-functional disconnection means shall be left in the open position		P
	- at least basic or simple separation shall be maintained between the PV input and the mains		P
	- the inverter shall not start operation		P
	- the inverter shall indicate a fault in accordance with 13.9	The screen shown error information.	P
4.4.4.16 of IEC 62109-2	A stand-alone inverter with a transfer switch to transfer AC loads from the mains or other AC bypass source to the inverter output:	No such transfer switch	N/A
	- shall continue to operate normally		N/A
	- shall not present a risk of fire as the result of an out-of-phase transfer		N/A
	- shall not present a risk of shock as the result of an out-of-phase transfer		N/A
	- And having control preventing switching: components for malfunctioning		N/A
4.4.4.17 of IEC 62109-2	Cooling system failure – Blanketing test No hazards according to the criteria of sub-clause 4.4.3 of Part 1 shall result from blanketing the inverter This test is not required for inverters restricted to use only in closed electrical operating areas.	See appended table.	P
	Test stop condition: time duration value or stabilized temperature	Considered.	P
4.5	Humidity preconditioning		P
4.5.1	General		P
4.5.2	Conditions		P
4.6	Backfeed voltage protection	Considered.	P
4.6.1	Backfeed tests under normal conditions		P



IEC/EN 62109-1, IEC/EN 62109-2			
Clause	Requirement – Test	Result – Remark	Verdict
	Each input source shall be tested separately by first disconnecting the source and then by deenergizing the source (if possible).		P
4.6.2	Backfeed tests under single-fault conditions	Considered.	P
	The tests in 4.6.1 are repeated for each single fault condition under consideration. Faults to be applied are selected based on analysis of schematics of the circuitry with particular attention to devices that control or transfer energy between different sources.		P
4.6.3	Compliance with backfeed tests	Considered.	P
	The PCE is compliant with the requirements if during the tests in 4.6.1 and 4.6.2 no hazardous voltage or energy is present on the PCE terminals for the source under test. Measurements are taken 15 s or 1 s after the source is de-energized or disconnected, as follows:		P
	– 15 s for sources that are permanently connected;		P
	– 1 s for sources that are cord-connected or use connectors that can be opened without the use of a tool.	Permanently connected.	N/A
4.7	Electrical ratings tests	See appended table.	P
4.7.1	Input ratings	See appended table.	P
	While operating under the reference test conditions of 4.2.2, the measured continuous input current or power, as applicable, shall not exceed the marked input ratings by more than 10 %.	See appended table.	P
4.7.1.1	Measurement requirements for DC input ports		P
4.7.2	Output ratings		P
	While operating under the reference test conditions of 4.2.2, each output port of the PCE shall be capable of providing its marked output power or current ratings, as applicable, without overcurrent protective devices operating and without shutdown due to operation of overtemperature protection systems. The measured continuous output current or power, as applicable, shall not exceed the marked output ratings by more than 10 %.	Considered.	P
4.7.3 of IEC 62109-2	Measurement requirements for AC output ports for stand-alone inverters	Grid-interactive inverter.	N/A
4.7.4 of IEC 62109-2	Stand-alone Inverter AC output voltage and frequency	Grid-interactive inverter.	N/A
4.7.4.1 of IEC 62109-2	General	Grid-interactive inverter.	N/A
4.7.4.2 of IEC 62109-2	Steady state output voltage at nominal DC input The steady-state AC output voltage shall not be less than 90 % or more than 110 % of the rated nominal voltage with the inverter supplied with its nominal value of DC input voltage.	Grid-interactive inverter.	N/A



IEC/EN 62109-1, IEC/EN 62109-2			
Clause	Requirement – Test	Result – Remark	Verdict
4.7.4.3 of IEC 62109-2	Steady state output voltage across the DC input range The steady-state AC output voltage shall not be less than 85 % or more than 110 % of the rated nominal voltage with the inverter supplied with any value within the rated range of DC input voltage.	Grid-interactive inverter.	N/A
4.7.4.4 of IEC 62109-2	Load step response of the output voltage at nominal DC input The AC output voltage shall not be less than 85 % or more than 110 % of the rated nominal voltage for more than 1,5 s after application or removal of a resistive load.	Grid-interactive inverter.	N/A
4.7.4.5 of IEC 62109-2	Steady state output frequency The steady-state AC output frequency shall not vary from the nominal value by more than +4 % or –6 %.	Grid-interactive inverter.	N/A
4.7.5 of IEC 62109-2	Stand-alone inverter output voltage waveform	Grid-interactive inverter.	N/A
4.7.5.1 of IEC 62109-2	General	Grid-interactive inverter.	N/A
4.7.5.2 of IEC 62109-2	The AC output voltage waveform of a sinusoidal output stand-alone inverter shall have a total harmonic distortion (THD) not exceeding of 10 % and no individual harmonic at a level exceeding 6 %.	Grid-interactive inverter.	N/A
4.7.5.3 of IEC 62109-2	Non-sinusoidal output waveform requirements	Grid-interactive inverter.	N/A
4.7.5.3.1 of IEC 62109-2	General	Grid-interactive inverter.	N/A
4.7.5.3.2 of IEC 62109-2	The total harmonic distortion (THD) of the voltage waveform shall not exceed 40 %.	Grid-interactive inverter.	N/A
4.7.5.3.3 of IEC 62109-2	The slope of the rising and falling edges of the positive and negative half-cycles of the voltage waveform shall not exceed 10 V/μs measured between the points at which the waveform has a voltage of 10 % and 90 % of the peak voltage for that half-cycle.	Grid-interactive inverter.	N/A
4.7.5.3.4 of IEC 62109-2	The absolute value of the peak voltage of the positive and negative half-cycles of the waveform shall not exceed 1,414 times 110 % of the RMS value of the rated nominal AC output voltage.	Grid-interactive inverter.	N/A
4.7.5.4 of IEC 62109-2	Information requirements for non-sinusoidal waveforms The instructions provided with a stand-alone inverter not complying with 4.7.5.2 shall include the information in 5.3.2.6.	Grid-interactive inverter.	N/A
4.7.5.5 of IEC 62109-2	Output voltage waveform requirements for inverters for dedicated loads	Grid-interactive inverter.	N/A



IEC/EN 62109-1, IEC/EN 62109-2			
Clause	Requirement – Test	Result – Remark	Verdict
	For an inverter that is intended only for use with a known dedicated load, the following requirements may be used as an alternative to the waveform requirements in 4.7.5.2 to 4.7.5.3.	Grid-interactive inverter.	N/A
	The combination of the inverter and dedicated load shall be evaluated to ensure that the output waveform does not cause any hazards in the load equipment and inverter, or cause the load equipment to fail to comply with the applicable product safety standards.	Grid-interactive inverter.	N/A
	The inverter shall be marked with symbols 9 and 15 of Table C.1 of Part 1.	Grid-interactive inverter.	N/A
	The installation instructions provided with the inverter shall include the information in 5.3.2.13.	Grid-interactive inverter.	N/A
4.8 of IEC 62109-2	Additional tests for grid-interactive inverters	Considered.	P
4.8.1 of IEC 62109-2	General requirements regarding inverter isolation and array grounding	Non-isolation inverter.	N/A
	- Type of Array grounding supported		N/A
	- Inverter isolation		N/A
4.8.2 of IEC 62109-2	Array insulation resistance detection for inverters for ungrounded and functionally grounded arrays	Inverter checks the array isolation resistance before start up.	P
4.8.2.1 of IEC 62109-2	Array insulation resistance detection for inverters for ungrounded arrays	Considered.	P
	Inverter shall have means to measure DC insulation resistance from PV input (array) to ground before starting operation	Considered.	P
	Or Inverter shall be provided with instruction in accordance with 5.3.2.11.		P
	Measured DC insulation resistance:	See appended table.	P
	Inverter measurement circuit shall be capable of detecting insulation resistance below the limit value $R = V_{max}/30mA$ under normal conditions	Considered.	P
	Inverter measurement circuit shall be capable of detecting insulation resistance below the limit value $R = V_{max}/30mA$ with ground fault in the PV array	Considered.	P
	Isolated inverters shall indicate a fault if the insulation resistance is less than the limit value	The product is a non-isolated inverter.	N/A
	Isolated inverter fault indication maintained until insulation resistance has recovered to a value higher than the limit value		P
	Non-isolated inverters, or inverters with isolation not complying with the leakage current limits in the minimum inverter isolation requirements in Table 30:		P
	- shall indicate a fault in accordance with 13.9	Screen shown the error information.	P
	- shall not connect to the mains	Relay keep up opened.	P
4.8.2.2 of IEC 62109-2	Array insulation resistance detection for inverters for functionally grounded arrays	Inverter did not intend connected functionally grounded arrays.	N/A



IEC/EN 62109-1, IEC/EN 62109-2			
Clause	Requirement – Test	Result – Remark	Verdict
	a-1) The value of the total resistance, including the intentional resistance for array functional grounding, the expected insulation resistance of the array to ground, and the resistance of any other networks connected to ground (for example measurement networks) must not be lower than $R = (V_{MAX} PV/30 \text{ mA})$ ohms.		N/A
	a-2) The installation instructions shall include the information required in 5.3.2.12.		N/A
	b-1) As an alternative to a), or if a resistor value lower than in a) is used, the inverter shall incorporate means to detect, during operation, if the total current through the resistor and any networks (for example measurement networks) in parallel with it, exceeds the residual current values and times in Table 31		N/A
	b-2) Inverter shall either disconnect the resistor or limit the current by other means		N/A
	b-3) If the inverter is a non-isolated inverter, or has isolation not complying with the leakage current limits in the minimum inverter isolation requirements in Table 30, it shall also disconnect from the mains.		N/A
	c) The inverter shall have means to measure the DC insulation resistance from the PV input to ground before starting operation, in accordance with 4.8.2.1.		N/A
4.8.3 of IEC 62109-2	Array residual current detection		P
4.8.3.1 of IEC 62109-2	General	See below.	P
4.8.3.2 of IEC 62109-2	30 mA touch current type test for isolated inverters	Non-isolated inverters.	N/A
4.8.3.3 of IEC 62109-2	Fire hazard residual current type test for isolated inverters	Non-isolated inverters.	N/A
4.8.3.4 of IEC 62109-2	Protection by application of RCD's	The PCE provides an integrated RCDs.	N/A
	- The requirement for additional protection in 4.8.3.1 can be met by provision of an RCD with a residual current setting of 30 mA, located between the inverter and the mains..		N/A
	- The selection of the RCD type to ensure compatibility with the inverter must be made according to rules for RCD selection in Part 1.		N/A
	- The RCD provided integral to the inverter, or		N/A
	- The RCD provided by the installer if details of the rating, type, and location for the RCD are given in the installation instructions per 5.3.2.9.		N/A
4.8.3.5 of IEC 62109-2	Protection by residual current monitoring	See below.	P



IEC/EN 62109-1, IEC/EN 62109-2			
Clause	Requirement – Test	Result – Remark	Verdict
4.8.3.5.1 of IEC 62109-2	General	The PCE provides an integrated RCDs.	P
	Where required by Table 30, the inverter shall provide residual current monitoring that functions whenever the inverter is connected to the mains with the automatic disconnection means closed.	The residual current will be measuring before start up.	P
	The residual current monitoring means shall measure the total (both a.c. and d.c. components) RMS current.	Considered.	P
	As indicated in Table 30 for different inverter types, array types, and inverter isolation levels, detection may be required for excessive continuous residual current, excessive sudden changes in residual current, or both, according to the following limits:	Considered.	P
	a) Continuous residual current: The inverter shall disconnect within 0,3 s and indicate a fault in accordance with 13.9 if the continuous residual current exceeds:	See appended table.	P
	- maximum 300 mA for inverters with continuous output power rating ≤ 30 kV;	See appended table.	P
	- maximum 10 mA per kVA of rated continuous output power for inverters with continuous output power rating > 30 kVA.		N/A
	The inverter may attempt to re-connect if the array insulation resistance meets the limit in 4.8.2.		P
	b) Sudden changes in residual current: The inverter shall disconnect from the mains within the time specified in Table 31	See appended table.	P
	The inverter indicates a fault in accordance with 13.9, if a sudden increase in the RMS residual current is detected exceeding the value in the table.	See appended table.	P
	- monitoring for the continuous condition in a) is not required for an inverter with isolation complying with 4.8.3.3;		P
	- monitoring for the sudden changes in b) is not required for an inverter with isolation complying with 4.8.3.2.		P
	The inverter may attempt to re-connect if the array insulation resistance meets the limit in 4.8.2.		P
4.8.3.5.2 of IEC 62109-2	Test for detection of excessive continuous residual current: test repeated 5 times and time to disconnect shall not exceed 0,3 s.	See appended table.	P
4.8.3.5.3 of IEC 62109-2	Test for detection of sudden changes in residual current repeated 5 times and each of the 5 results shall not exceed the time limit indicated in for each row (30mA, 60mA and 150mA) of Table 31.	See appended table.	P
4.8.3.6 of IEC 62109-2	Systems located in closed electrical operating areas	No located in closed electrical operating areas.	N/A



IEC/EN 62109-1, IEC/EN 62109-2			
Clause	Requirement – Test	Result – Remark	Verdict
	The protection against shock hazard is not required if the installation information provided with the inverter indicates the restriction for use in a closed electrical operating area, and		N/A
	Installation information indicates what forms of shock hazard protection are and are not provided integral to the inverter, in accordance with 5.3.2.7.		N/A
	The inverter shall be marked as in 5.2.2.6.		N/A

5	MARKING AND DOCUMENTATION		P
5.1	Marking	See below	P
5.1.1	General	See below	P
	Equipment shall bear markings as specified in 5.1 and 5.2	The marking plate is on the outer surface of enclosure.	P
	Graphic symbols may be used and shall be in accordance with Annex C or IEC 60417 as applicable.	All used graphic symbols are in accordance with Annex C.	P
	Graphic symbols shall be explained in the documentation provided with the PCE.	The explanations are provided in the manual.	P
5.1.2	Durability of markings	See below	P
	Markings required by this clause to be located on the PCE shall remain clear and legible under conditions of NORMAL USE and resist the effects of cleaning agents specified by the manufacturer	After this test, the markings are clearly legible. There was neither loose nor curling on the edge of label.	P
5.1.3	Identification		P
	The equipment shall, as a minimum, be permanently marked with:	See below	P
	a) the name or trade mark of the manufacturer or supplier		P
	b) model number, name or other means to identify the equipment	The model name is provided on the label.	P
	c) a serial number, code or other marking allowing identification of manufacturing location and the manufacturing batch or date within a three month time period.	The serial number is provided on the label.	P
5.1.4	Equipment ratings		P
	Unless otherwise specified in another part of IEC 62109, the following ratings, as applicable shall be marked on the equipment:	See below	P
	– input voltage, type of voltage (a.c. or d.c.), frequency, and max. continuous current for each input	The input voltage, type of voltage (d.c.) and max. continuous current for each input are marked on the marking label.	P
	– output voltage, type of voltage (a.c. or d.c.), frequency, max. continuous current, and for a.c. outputs, either the power or power factor for each output	The output voltage type of voltage (a.c.), frequency, max. continuous current and power factor for each output are marked on the marking label.	P



IEC/EN 62109-1, IEC/EN 62109-2			
Clause	Requirement – Test	Result – Remark	Verdict
	– the ingress protection (IP) rating as in 6.3 below	IP65 is marked on the label.	P
5.1.4 of IEC 62109-2	Replacement: In addition to the markings required in other clauses of Part 1 and elsewhere in this Part 2, the ratings in Table 32 shall be plainly and permanently marked on the inverter, where it is readily visible after installation. Only those ratings that are applicable based on the type of inverter are required.	The rating mark plate has been placed on the front enclosure and it is visible after mounted.	P
	PV input ratings:	See below	P
	– Vmax PV (absolute maximum) (d.c. V)	SOFAR 1100TL , SOFAR 1600TL: 450 d.c. V SOFAR 2200TL , SOFAR 2700TL, SOFAR 3000TL: 550 d.c. V	P
	– Isc PV (absolute maximum) (d.c. A)	SOFAR 1100TL , SOFAR 1600TL, SOFAR 2200TL : 12 d.c. A SOFAR 2700TL, SOFAR 3000TL: 15 d.c. A	P
	a.c.output ratings:	See below	P
	– Voltage (nominal or range) (a.c. V)	230a.c. V	P
	– Current (maximum continuous) (a.c. A)	SOFAR 1100TL: 4.5 a.c. A SOFAR 1600TL: 7.0 a.c. A SOFAR 2200TL: 9.5 a.c. A SOFAR 2700TL: 11.5 a.c. A SOFAR 3000TL: 13.0 a.c. A	P
	– Frequency (nominal or range) (Hz)	50/60Hz	P
	– Power (maximum continuous) (W or VA)	SOFAR 1100TL: 1000W SOFAR 1600TL: 1500W SOFAR 2200TL: 2000W SOFAR 2700TL: 2500W SOFAR 3000TL: 2800W	P
	– Power factor range	1	P
	a.c input ratings:	No a.c input	N/A
	– Voltage (nominal or range) (a.c. V)		N/A
	– Current (maximum continuous) (a.c. A)		N/A
	– Frequency (nominal or range) (Hz)		N/A
	d.c input (other than PV) ratings:	No such parts	N/A
	– Voltage (nominal or range) (d.c. V)		N/A
	– Current (maximum continuous) (d.c. A)		N/A
	d.c. output ratings:	No d.c output	N/A
	– Voltage (nominal or range) (d.c. V)		N/A
	– Current (maximum continuous) (d.c. A)		N/A
	Protective class (I or II or III)	Class I	P
	Ingress protection (IP) rating per part 1	IP 65	P
5.1.5	Fuse identification		P



IEC/EN 62109-1, IEC/EN 62109-2			
Clause	Requirement – Test	Result – Remark	Verdict
	Marking shall be located adjacent to each fuse or fuseholder, or on the fuseholder, or in another location provided that it is obvious to which fuse the marking applies, giving the fuse current rating and where fuses of different voltage rating value could be fitted, the fuse voltage rating.		N/A
	Where fuses with special fusing characteristics such as time delay or breaking capacity are necessary, the type shall also be indicated		N/A
	For fuses not located in operator access areas and for soldered-in fuses located in operator access areas, it is permitted to provide an unambiguous cross-reference (for example, F1, F2, etc.) to the servicing instructions which shall contain the relevant information.		P
5.1.6	Terminals, Connections, and Controls	See below	P
	If necessary for safety, an indication shall be given of the purpose of Terminals, connectors, controls, and indicators, and their various positions, including any connections for coolant fluids such as water and drainage. The symbols in Annex C may be used, and where there is insufficient space, symbol 9 of Annex C may be used.	The indications were provided adjacent to AC terminals and DC terminal.	P
	Push-buttons and actuators of emergency stop devices, and indicator lamps used only to indicate a warning of danger or the need for urgent action shall be coloured red.	No such device	N/A
	A multiple-voltage unit shall be marked to indicate the particular voltage for which it is set when shipped from the factory. The marking is allowed to be in the form of a paper tag or any other nonpermanent material.	No such device	N/A
	A unit with d.c. terminals shall be plainly marked indicating the polarity of the connections, with:	See below	P
	– the sign “+” for positive and “-”, for negative; or	The “+” and “-” marking were provided adjacent to the DC input terminals.	P
	– a pictorial representation illustrating the proper polarity where the correct polarity can be unambiguously determined from the representation	No pictorial representation illustration used.	N/A
5.1.6.1	Protective Conductor Terminals		P
	The means of connection for the protective earthing conductor shall be marked with:	See below	P
	– symbol 7 of Annex C; or	The symbol of annex C was marked adjacent to the PE terminal.	P
	– the letters “PE”; or	Symbol 7 of Annex C was used.	N/A
	– the colour coding green-yellow.		P
5.1.7	Switches and circuit-breakers	Approved switch was used for all models.	P



IEC/EN 62109-1, IEC/EN 62109-2			
Clause	Requirement – Test	Result – Remark	Verdict
	The on and off-positions of switches and circuits breakers shall be clearly marked. If a push-button switch is used as the power switch, symbols 10 and 16 of Annex C may be used to indicate the on-position, or symbols 11 and 17 to indicate the off-position, with the pair of symbols (10 and 16, or 11 and 17) close together.	“ON” indicated the on-position of DC switch. “OFF” indicated the off-position of DC switch.	P
5.1.8	Class II Equipment	Class I equipment.	N/A
	Equipment using Class II protective means throughout shall be marked with symbol 12 of Annex C. Equipment which is only partially protected by DOUBLE INSULATION or REINFORCED INSULATION shall not bear symbol 12 of Table Annex C.		N/A
	Where such equipment has provision for the connection of an earthing conductor for functional reasons (see 7.3.6.4) it shall be marked with symbol 6 of Annex C		N/A
5.1.9	Terminal boxes for External Connections	No such parts.	N/A
	Where required by note 1 of Table 2 as a result of high temperatures of terminals or parts in the wiring compartment, there shall be a marking, visible beside the terminal before connection, of either:		N/A
	a) the minimum temperature Rating and size of the cable to be connected to the TERMINALS; or		N/A
	b) a marking to warn the installer to consult the installation instruction. Symbol 9 of Table D-1 is an acceptable marking		N/A
5.2	Warning markings		P
5.2.1	Visibility and legibility requirements for warning markings	See below	P
	Warning markings shall be legible, and shall have minimum dimensions as follows:		P
	– Printed symbols shall be at least 2.75 mm high	The symbols were at least 2,75 mm high.	P
	– Printed text characters shall be at least 1.5 mm high and shall contrast in colour with the background	The text characters were at least 1,5 mm high.	P
	– Symbols or text that are moulded, stamped or engraved in a material shall have a character height of at least 2,0 mm, and if not contrasting in colour from the background, shall have a depth or raised height of at least 0,5 mm.	The symbols or text are marking on the label.	N/A
	If it is necessary to refer to the instruction manual to preserve the protection afforded by the equipment, the equipment shall be marked with symbol 9 of Annex C	The symbol 9 of Annex C was provided on the label.	P
	Symbol 9 of Annex C is not required to be used adjacent to symbols that are explained in the manual	All symbols are explained in the manual.	P
5.2.2	Content for warning markings	See below	P



IEC/EN 62109-1, IEC/EN 62109-2			
Clause	Requirement – Test	Result – Remark	Verdict
5.2.2.1	Ungrounded heatsinks and similar parts	All accessible metal parts were grounded.	N/A
	An ungrounded heat sink or other part that may be mistaken for a grounded part and involves a risk of electric shock in accordance with 7.3 shall be marked with symbol 13 of Annex C, or equivalent. The marking may be on or adjacent to the heatsink and shall be clearly visible when the PCE is disassembled to the extent that a risk of contact with the heatsink exists.		N/A
5.2.2.2	Hot Surfaces		P
	A part of the PCE that exceeds the temperature limits specified in 4.3.2 shall be marked with symbol 14 of Annex C or equivalent.	The symbol 14 of Annex C provided on the warning label which located on the surface of enclosure.	P
5.2.2.3	Coolant	No coolant contained within the equipment.	N/A
	A unit containing coolant that exceeds 70 °C shall be legibly marked externally where readily visible after installation with symbol 15 of Annex C. The documentation shall provide a warning regarding the risk of burns from hot coolant, and either:		N/A
	a) statement that coolant system servicing is to be done only by SERVICE PERSONNEL, or		N/A
	b) instructions for safe venting, draining, or otherwise working on the cooling system, if these operations can be performed without OPERATOR access to HAZARDS internal to the equipment		N/A
5.2.2.4	Stored energy	See below	P
	Where required by 7.3.9.2 or 7.4.2 the PCE shall be marked with Symbol 21 of Annex C and the time to discharge capacitors to safe voltage and energy levels shall accompany the symbol.	The symbol 21 of Annex C and “5min” were provided on the label.	P
5.2.2.5	Motor guarding	No such devices which can conducted injury to service personal..	N/A
	Where required by 8.2 a marking shall be provided where it is visible to service personnel before removal of a guard, warning of the hazard and giving instructions for safe servicing (for example disconnection of the source before removing the guard).		N/A
5.2.2.6 of IEC 62109-2	Inverters for closed electrical operating areas	Not such equipment.	N/A
	Where required by 4.8.3.6, an inverter not provided with full protection against shock hazard on the PV array shall be marked with a warning that the inverter is only for use in a closed electrical operating area, and referring to the installation instructions.		N/A



IEC/EN 62109-1, IEC/EN 62109-2			
Clause	Requirement – Test	Result – Remark	Verdict
5.2.3	Sonic hazard markings and instructions	No any hazardous noise level from the equipment.	N/A
	If required by 10.2.1 a PCE shall:		N/A
	a) be marked to warn the operator of the sonic pressure hazard; or		N/A
	b) be provided with installation instructions that specify how the installer can ensure that the sound pressure level from equipment at its point of use after installation, will not reach a value, which could cause a hazard. These instructions shall include the measured sound pressure level, and shall identify readily available and practicable protective materials or measures which may be used.		N/A
5.2.4	Equipment with multiple sources of supply	See below	P
	A PCE with connections for multiple energy sources shall be marked with symbol 13 of Annex C and the manual shall contain the information required in 5.3.4.	Marked with symbol 13 of Annex C and explain in user manual.	P
	The symbol shall be located on the outside of the unit or shall be prominently visible behind any cover giving access to hazardous parts.		P
5.2.5	Excessive touch current	No touch current exceeded 3,5mA a.c. Under any operation conditions.	N/A
	Where required by 7.3.6.3.7 the PCE shall be marked with symbol 15 of Annex C. See also 5.3.2 for information to be provided in the installation manual.		N/A
5.3	Documentation		P
5.3.1	General		P
	The documentation provided with the PCE shall provide the information needed for the safe operation, installation, and (where applicable) maintenance of the equipment. The documentation shall include the items required in 5.3.2 through 5.3.4, and the following:	Considered.	P
	a) explanations of equipment markings, including symbols used	Considered.	P
	b) location and function of terminals and controls	Considered.	P
	c) all ratings or specifications that are necessary to safely install and operate the PCE, including the following environmental ratings along with an explanation of their meaning and any resulting installation requirements:	Considered.	P
	– ENVIRONMENTAL CATEGORY as per 6.1	Both indoor and outdoor.	P
	– WET LOCATIONS classification for the intended external environment as per 6.1	Dry location use only.	N/A
	– POLLUTION DEGREE classification for the intended external environment as per 6.2	PDII	P



IEC/EN 62109-1, IEC/EN 62109-2			
Clause	Requirement – Test	Result – Remark	Verdict
	– INGRESS PROTECTION rating as per 6.3	IP65	P
	– Ambient temperature and relative humidity ratings	-25°C~+60°C	P
	– MAXIMUM altitude rating	Up to 2000m.	P
	– OVERVOLTAGE CATEGORY assigned to each input and output port as per 7.3.7.1.2, accompanied by guidance regarding how to ensure that the installation complies with the required overvoltage categories;	PV side: OVCII AC side: OVCIII	P
	d) a warning that when the photovoltaic array is exposed to light, it supplies a d.c. voltage to the PCE	Considered.	P
5.3.1.1	Language		P
	Instructions related to safety shall be in a language that is acceptable in the country where the equipment is to be installed.	Considered.	P
5.3.1.2	Format		P
	In general, the documentation must be provided in printed form and is to be delivered with the equipment.	Considered.	P
	For equipment which requires the use of a computer for both installation and operation, documentation may be provided in electronic format without accompanying printed format.	Considered.	P
5.3.2	Information related to installation		P
	The documentation shall include installation and where applicable, specific commissioning instructions and, if necessary for safety, warnings against hazards which could arise during installation or commissioning of the equipment. The information provided shall include:	Considered.	P
	a) assembly, location, and mounting requirements:	Reference installation instruction.	P
	b) ratings and means of connection to each source of supply and any requirements related to wiring and external controls, colour coding of leads, disconnection means, or overcurrent protection needed, including instructions that the installation position shall not prevent access to the disconnection means;	Reference installation instruction.	P
	c) ratings and means of connection of any outputs from the PCE, and any requirements related to wiring and external controls, colour coding of leads, or overcurrent protection needed;	Reference installation instruction.	P
	d) explanation of the pin-out of connectors for external connections, unless the connector is used for a standard purpose (e.g. RS 232)	Reference installation instruction.	P



IEC/EN 62109-1, IEC/EN 62109-2			
Clause	Requirement – Test	Result – Remark	Verdict
	e) ventilation requirements;	Reference installation instruction.	P
	f) requirements for special services, for example cooling liquid;	No special services.	N/A
	g) instructions and information relating to sound pressure level if required by 10.2.1;	Pressure level was not exceed 10.2.1 requirement.	N/A
	h) where required by 14.8.1.3, instructions for the adequate ventilation of the room or location in which PCE containing vented or valve-regulated batteries is located, to prevent the accumulation of hazardous gases;	PCE without containing Vented or valve-regulated batteries.	N/A
	i) tightening torque to be applied to wiring terminals;	Reference installation instruction.	P
	j) values of backfeed short-circuit currents available from the PCE on input and output conductors under fault conditions, if those currents exceeds the max. rated current of the circuit, as per 4.4.4.6;	No any short-circuit currents exceeds the max. rated current of circuit.	N/A
	k) for each input to the PCE, the max value of short-circuit current available from the source, for which the PCE is designed; and	Considered.	P
	l) compatibility with RCD and RCM;	Built-in RCMUs.	P
	m) instructions for protective earthing, including the information required by 7.3.6.3.7 if a second protective earthing conductor is to be installed:	Reference installation instruction.	P
	n) where required by 7.3.8, the installation instructions shall include the following or equivalent wording:	Built-in RCMUs.	N/A
	“This product can cause a d.c. current in the external protective earthing conductor. Where a residual current-operated protective (RCD) or monitoring (RCM) device is used for protection in a case of direct or indirect contact, only an RCD or RCM of Type B is allowed on the supply side of this product.”	Built-in RCMUs, beside a d.c. current in the external protective earthing conductor has less then 6mA on the normal or fault conditions, so an RCD or RCM of Type is not necessary.	N/A
	o) for PCE intended to charge batteries, the battery nominal voltage rating, size, and type	No batteries.	N/A
	p) PV array configuration information, such as ratings, whether the array is to be grounded or floating, any external protection devices needed, etc.	PV array should be floating configuration to be connected to PCE, relant information had shown on the installation manual.	P
5.3.2.1 of IEC 62109-2	Ratings		P



IEC/EN 62109-1, IEC/EN 62109-2			
Clause	Requirement – Test	Result – Remark	Verdict
	Subclause 5.3.2 of Part 1 requires the documentation to include ratings information for each input and output. For inverters this information shall be as in Table 33 below. Only those ratings that are applicable based on the type of inverter are required.		P
	PV input quantities :	See below	P
	– Vmax PV (absolute maximum) (d.c. V)	SOFAR 1100TL , SOFAR 1600TL: 450 d.c. V SOFAR 2200TL , SOFAR 2700TL, SOFAR 3000TL: 550 d.c. V	P
	– PV input operating voltage range (d.c. V)	SOFAR 1100TL , SOFAR 1600TL: 90-400 d.c. V SOFAR 2200TL , SOFAR 2700TL, SOFAR 3000TL: 100-480 d.c. V	P
	– Maximum operating PV input current (d.c. A)	SOFAR 1100TL , SOFAR 1600TL, SOFAR 2200TL : 10 d.c. A SOFAR 2700TL, SOFAR 3000TL: 13 d.c. A	P
	– Isc PV (absolute maximum) (d.c. A)	SOFAR 1100TL , SOFAR 1600TL, SOFAR 2200TL : 12 d.c. A SOFAR 2700TL, SOFAR 3000TL: 15 d.c. A	P
	– Max. inverter backfeed current to the array (a.c. or d.c. A)	No backfeed current to the array.	P
	a.c. output quantities:	See below	P
	– Voltage (nominal or range) (a.c. V)	230a.c. V	P
	– Current (maximum continuous) (a.c. A)	SOFAR 1100TL: 4.5 a.c. A SOFAR 1600TL: 7.0 a.c. A SOFAR 2200TL: 9.5 a.c. A SOFAR 2700TL: 11.5 a.c. A SOFAR 3000TL: 13.0 a.c. A	P
	– Current (inrush) (a.c. A, peak and duration)	0.8a.c.A, 2us	P
	– Frequency (nominal or range) (Hz)	50/60Hz	P
	– Power (maximum continuous) (W or VA)	SOFAR 1100TL: 1000W SOFAR 1600TL: 1500W SOFAR 2200TL: 2000W SOFAR 2700TL: 2500W SOFAR 3000TL: 2800W	P
	– Power factor range	1	P
	– Maximum output fault current (a.c. A, peak and duration or RMS)	200a.c.A, 0.1us;	P



IEC/EN 62109-1, IEC/EN 62109-2			
Clause	Requirement – Test	Result – Remark	Verdict
	– Maximum output overcurrent protection (a.c. A)	SOFAR 1100TL: 4.5 a.c. A SOFAR 1600TL: 7.0 a.c. A SOFAR 2200TL: 9.5 a.c. A SOFAR 2700TL: 11.5 a.c. A SOFAR 3000TL: 13.0 a.c. A	P
	a.c. input quantities:	No a.c input	N/A
	– Voltage (nominal or range) (a.c. V)		N/A
	– Current (maximum continuous) (a.c. A)		N/A
	– Current (inrush) (a.c. A, peak and duration)		N/A
	– Frequency (nominal or range) (Hz)		N/A
	d.c input (other than PV) quantities:	No d.c input	N/A
	– Voltage (nominal or range) (d.c. V)		N/A
	– Nominal battery voltage (d.c. V)		N/A
	– Current (maximum continuous) (d.c. A)		N/A
	d.c. output quantities:	No d.c output	N/A
	– Voltage (nominal or range) (d.c. V)		N/A
	– Nominal battery voltage (d.c. V)		N/A
	– Current (maximum continuous) (d.c. A)		N/A
	Protective class (I or II or III)	Class I	P
	Ingress protection (IP) rating per part 1	IP65	P
5.3.2.2 of IEC 62109-2	Grid-interactive inverter setpoints		N/A
	For a grid-interactive unit with field adjustable trip points, trip times, or reconnect times, the presence of such controls, the means for adjustment, the factory default values, and the limits of the ranges of adjustability shall be provided in the documentation for the PCE or in other format such as on a website.	No adjustable setting available. Only the factory default values, however the adjustment shall be performed by distribution network operator.	N/A
5.3.2.3 of IEC 62109-2	Transformers and isolation	Transformerless PCE	N/A
	An inverter shall be provided with information to the installer regarding whether an internal isolation transformer is provided, and if so, what level of insulation (functional, basic, reinforced, or double) is provided by that transformer. The instructions shall also indicate what the resulting installation requirements are regarding such things as earthing or not earthing the array, providing external residual current detection devices, requiring an external isolation transformer, etc.		N/A
5.3.2.4 of IEC 62109-2	Transformers required but not provided	Transformerless PCE.	N/A



IEC/EN 62109-1, IEC/EN 62109-2			
Clause	Requirement – Test	Result – Remark	Verdict
	An inverter that requires an external isolation transformer not provided with the unit, shall be provided with instructions that specify the configuration type, electrical ratings, and environmental ratings for the external isolation transformer with which it is intended to be used.		N/A
5.3.2.5 of IEC 62109-2	PV modules for non-isolated inverters		P
	Non-isolated inverters shall be provided with installation instructions that require PV modules that have an IEC 61730 Class A rating. If the maximum AC mains operating voltage is higher than the PV array maximum system voltage then the instructions shall require PV modules that have a maximum system voltage rating based upon the AC mains voltage.	Considered.	P
5.3.2.6 of IEC 62109-2	Non-sinusoidal output waveform information	Sinusoidal output waveform.	N/A
	The instruction manual for a stand-alone inverter not complying with 4.7.5.2 shall include a warning that the waveform is not sinusoidal, that some loads may experience increased heating, and that the user should consult the manufacturers of the intended load equipment before operating that load with the inverter. The inverter manufacturer shall provide information regarding what types of loads may experience increased heating, recommendations for maximum operating times with such loads, and shall specify the THD, slope, and peak voltage of the waveforms as determined by the testing in 4.7.5.3.2 through 4.7.5.3.4.		N/A
5.3.2.7 of IEC 62109-2	Systems located in closed electrical operating areas	No such parts.	N/A
	Where required by 4.8.3.6, an inverter not provided with full protection against shock hazard on the PV array shall be provided with installation instructions requiring that the inverter and the array must be installed in closed electrical operating areas, and indicating which forms of shock hazard protection are and are not provided integral to the inverter (for example the RCD, isolation transformer complying with the 30 mA touch current limit, or residual current monitoring for sudden changes).		N/A
5.3.2.8 of IEC 62109-2	Stand-alone inverter output circuit bonding	Grid-interactive inverter.	N/A
	Where required by 7.3.10, the documentation for an inverter shall include the following:		N/A



IEC/EN 62109-1, IEC/EN 62109-2			
Clause	Requirement – Test	Result – Remark	Verdict
	– if output circuit bonding is required but is not provided integral to the inverter, the required means shall be described in the installation instructions, including which conductor is to be bonded and the required current carrying capability or cross-section of the bonding means;		N/A
	– if the output circuit is intended to be floating, the documentation for the inverter shall indicate that the output is floating.		N/A
5.3.2.9 of IEC 62109-2	Protection by application of RCD's	See below.	N/A
	Where the requirement for additional protection in 4.8.3.1 is met by requiring an RCD that is not provided integral to the inverter, as allowed by 4.8.3.4, the installation instructions shall state the need for the RCD, and shall specify its rating, type, and required circuit location.	The RCD protection is provided integral to the inverter.	N/A
5.3.2.10 of IEC 62109-2	Remote indication of faults	Considered.	P
	The installation instructions shall include an explanation of how to properly make connections to (where applicable), and use, the electrical or electronic fault indication required by 13.9.		P
5.3.2.11 of IEC 62109-2	External array insulation resistance measurement and response	Subclause 4.8.2.1 compliance.	N/A
	The installation instructions for an inverter for use with ungrounded arrays that does not incorporate all the aspects of the insulation resistance measurement and response requirements in 4.8.2.1, must include:	The PCE incorporates arrayinsulation resistance measurement.	N/A
	– for isolated inverters, an explanation of what aspects of array insulation resistance measurement and response are not provided, and an instruction to consult local regulations to determine if any additional functions are required or not;		N/A
	– for non-isolated inverters:		N/A
	• an explanation of what external equipment must be provided in the system, and		N/A
	• what the setpoints and response implemented by that equipment must be, and		N/A
	• how that equipment is to be interfaced with the rest of the system.		N/A
5.3.2.12 of IEC 62109-2	Array functional grounding information	No such requirements.	N/A



IEC/EN 62109-1, IEC/EN 62109-2			
Clause	Requirement – Test	Result – Remark	Verdict
	Where approach a) of 4.8.2.2 is used, the installation instructions for the inverter shall include all of the following:		N/A
	a) the value of the total resistance between the PV circuit and ground integral to the inverter;		N/A
	b) the minimum array insulation resistance to ground that system designer or installer must meet when selecting the PV panel and system design, based on the minimum value that the design of the PV functional grounding in the inverter was based on;		N/A
	c) the minimum value of the total resistance $R = V_{MAX} PV/30 \text{ mA}$ that the system must meet, with an explanation of how to calculate the total;		N/A
	d) a warning that there is a risk of shock hazard if the total minimum resistance requirement is not met.		N/A
5.3.2.13 of IEC 62109-2	Stand-alone inverters for dedicated loads	Grid-interactive inverter.	N/A
	Where the approach of 4.7.5.5 is used, the installation instructions for the inverter shall include a warning that the inverter is only to be used with the dedicated load for which it was evaluated, and shall specify the dedicated load.		N/A
5.3.2.14 of IEC 62109-2	Identification of firmware version(s)	See below	P
	An inverter utilizing firmware for any protective functions shall provide means to identify the firmware version. This can be a marking, but the information can also be provided by a display panel, communications port or any other type of user interface.	The firmware version is displayed on LCD display panel and disclosed by communication interface.	P
5.3.3	Information related to operation		P
	Instructions for use shall include any operating instructions necessary to ensure safe operation, including the following, as applicable:	See below	P
	– Instructions for adjustment of controls including the effects of adjustment;	Provided in the owner's manual.	P
	– Instructions for interconnection to accessories and other equipment, including indication of suitable accessories, detachable parts and any special materials;	Provided in the owner's manual.	P
	– Warnings regarding the risk of burns from surfaces permitted to exceed the temperature limits of 4.3.2 and required operator actions to reduce the risk; and	The temperature of surfaces did not exceed the limit of 4.3.2, however the 14 symbol was provided on the label.	P
	– Instructions, that if the equipment is used in a manner not specified by the manufacturer, the protection provided by the equipment may be impaired.	Provided in the user's manual.	P



IEC/EN 62109-1, IEC/EN 62109-2			
Clause	Requirement – Test	Result – Remark	Verdict
5.3.4	Information related to maintenance		P
	Maintenance instructions shall include the following:		P
	– Intervals and instructions for any preventive maintenance that is required to maintain safety (for example air filter replacement or periodic re-tightening of terminals);	Provided in the user's manual.	P
	– Instructions for accessing operator access areas, if any are present, including a warning not to enter other areas of the equipment;	Provided in the user's manual.	P
	– Part numbers and instructions for obtaining any required operator replaceable parts;	Provided in the user's manual.	P
	– Instructions for safe cleaning (if recommended)	Provided in the user's manual.	P
	– Where there is more than one source of supply energizing the PCE, information shall be provided in the manual to indicate which disconnect device or devices are required to be operated in order to completely isolate the equipment.	Provided in the user's manual.	P
5.3.4.1	Battery maintenance		N/A
	Where required by 14.8.5, the documentation shall include the applicable items from the following list of instructions regarding maintenance of batteries:	No batteries.	N/A
	– Servicing of batteries should be performed or supervised by personnel knowledgeable about batteries and the required precautions	No batteries.	N/A
	– When replacing batteries, replace with the same type and number of batteries or battery packs	No batteries.	N/A
	– General instructions regarding removal and installation of batteries	No batteries.	N/A
	– CAUTION: Do not dispose of batteries in a fire. The batteries may explode.	No batteries.	N/A
	– CAUTION: Do not open or damage batteries. Released electrolyte is harmful to the skin and eyes. It may be toxic.	No batteries.	N/A
	– CAUTION: A battery can present a risk of electrical shock and high short-circuit current. The following precautions should be observed when working on batteries:	No batteries.	N/A
	a) Remove watches, rings, or other metal objects.	No batteries.	N/A
	b) Use tools with insulated handles.	No batteries.	N/A
	c) Wear rubber gloves and boots.	No batteries.	N/A
	d) Do not lay tools or metal parts on top of batteries	No batteries.	N/A



IEC/EN 62109-1, IEC/EN 62109-2			
Clause	Requirement – Test	Result – Remark	Verdict
	e) Disconnect charging source prior to connecting or disconnecting battery terminals	No batteries.	N/A
	f) Determine if battery is inadvertently grounded. If inadvertently grounded, remove source from ground. Contact with any part of a grounded battery can result in electrical shock. The likelihood of such shock can be reduced if such grounds are removed during installation and maintenance (applicable to equipment and remote battery supplies not having a grounded supply circuit).	No batteries.	N/A

6	ENVIRONMENTAL REQUIREMENTS AND CONDITIONS		P
	The manufacturer shall rate the PCE for the following environmental conditions:	See below	P
	– ENVIRONMENTAL CATEGORY, as in 6.1 below	See below	P
	– Suitability for WET LOCATIONS or not	The PCE is for outdoor and indoor use.	P
	– POLLUTION DEGREE rating in 6.2 below	See 6.2.	P
	– INGRESS PROTECTION (IP) rating, as in 6.3 below	See 6.3.	P
	– Ultraviolet (UV) exposure rating, as in 6.4 below	See 6.4.	P
	– Ambient temperature and relative humidity ratings, as in 6.5 below	See 6.5.	P
6.1	Environmental categories and minimum environmental conditions		P
6.1.1	Outdoor	Considered	P
6.1.2	Indoor, unconditioned	The PCE is for outdoor and indoor use.	P
6.1.3	Indoor, conditioned	The PCE is for outdoor use.	N/A
6.2	Pollution degree	PD2 for internal environment, PD3 for external environment.	P
6.3	Ingress Protection	IP65	P
6.4	UV exposure	The displayer panel and connection terminals could protect against UV radiation.	P
6.5	Temperature and humidity	-25°C~+60°C, 0%~100% R.H.	P

7	PROTECTION AGAINST ELECTRIC SHOCK AND ENERGY HAZARDS		P
7.1	General	See below	P
7.2	Fault conditions	Refer to table 4.4.	P
7.3	Protection against electric shock		P
7.3.1	General	See below	P
7.3.2	Decisive voltage classification		P
7.3.2.1	Use of decisive voltage class (DVC)		P



IEC/EN 62109-1, IEC/EN 62109-2			
Clause	Requirement – Test	Result – Remark	Verdict
7.3.2.2	Limits of DVC (according table 6)	DVC-C is classified for d.c. input and a.c. output circuit. DVC-A is classified for circuitry of communication ports.	P
7.3.2.3	Short-terms limits of accessible voltages under fault conditions	See above	N/A
7.3.2.4	Requirements for protection (according table 7)	Considered	P
7.3.2.5	Connection to PELV and SELV circuits	DVC-A is classified for communication ports.	P
7.3.2.6	Working voltage and DVC	See below	P
7.3.2.6.1	General	Considered	P
7.3.2.6.2	AC working voltage (see Figure 2)	Considered	P
7.3.2.6.3	DC working voltage (see Figure 3)	Considered	P
7.3.2.6.4	Pulsating working voltage (see Figure 4)	Considered	P
7.3.3	protective separation		P
	Protective separation shall be achieved by:	See below	P
	<ul style="list-style-type: none"> ▪ double or reinforced insulation, or 	The double or reinforced insulation was provided between 1) DC input circuits and communication circuits; 2) AC output circuits and communication circuits.	P
	<ul style="list-style-type: none"> ▪ protective screening, i.e. by a conductive screen connected to earth by protective bonding in the PCE, or connected to the protective earth conductor itself, whereby the screen is separated from live parts by at least basic insulation, or 	All accessible metal parts were earthed and separated from live parts by at least basic insulation.	P
	<ul style="list-style-type: none"> ▪ protective impedance comprising limitation of current per 7.3.5.3 and of discharged energy per 7.3.5.4, or 	No such device.	N/A
	<ul style="list-style-type: none"> ▪ limitation of voltage according to 7.3.5.4. 	No such device.	N/A
	The protective separation shall be fully and effectively maintained under all conditions of intended use of the PCE	Considered	P
7.3.4	Protection against direct contact		P
7.3.4.1	General	See below	P
	Protection against direct contact is employed to prevent persons from touching live parts that do not meet the requirements of 7.3.5 and shall be provided by one or more of the measure given in 7.3.4.2 (enclosures and barriers) and 7.3.4.3 (insulation).	See 7.3.4.2 and 7.3.4.3	P
	Open type sub-assemblies and devices do not require protective measures against direct contact but the instruction provided with the equipment must indicate that such measures must be provided in the end equipment or in the installation.	No such device.	N/A
	Product intended for installation in CLOSED ELECTRICAL OPERATING AREAS, (see 3.9) need not have protective measures against direct contact, except as required by 7.3.4.2.4.	No such device.	N/A



IEC/EN 62109-1, IEC/EN 62109-2			
Clause	Requirement – Test	Result – Remark	Verdict
7.3.4.2	Protection by means of enclosures and barriers		P
	The following requirements apply where protection against contact with live parts is provided by enclosures or barriers, not by insulation in accordance with 7.3.4.3.	Considered	P
7.3.4.2.1	General	See below	P
	Parts of enclosures and barriers that provide protection in accordance with these requirements shall not be removable without the use of a tool (see 7.3.4.2.3).	Considered	P
	Polymeric materials used to meet these requirements shall also meet the requirements of 13.6	Considered	P
7.3.4.2.2	Access probe criteria		P
	Protection is considered to be achieved when the separation between the test probes and live parts, when tested as described below, is as follows:	See below	P
	a) decisive voltage classification A, (DVC A) - the probe may touch the live parts	Considered	P
	b) decisive voltage classification B, (DVC B) - the probe must not touch bare live parts	No DVC-B in the PCE.	N/A
	c) decisive voltage classification C, (DVC C) – the probe must have adequate clearance to live parts, based on the clearance for Basic insulation using the recurring peak working voltage involved,	Considered	P
7.3.4.2.3	Access probe tests		P
	Compliance with 7.3.4.2.1 is checked by all of the following:	See below	P
	a) Inspection; and	The live parts are enclosed within the earthed metal and no openings provided.	P
	b) Tests with the test finger (Figure D.1) and test pin (Figure D.2) of 0E, the results of which shall comply with the requirements of 7.3.4.2.1 a), b), and c) as applicable. Probe tests are performed on openings in the enclosures after removal of parts that can be detached or opened by an operator without the use of a tool, including fuseholders, and with operator access doors and covers open. It is permitted to leave lamps in place for this test. Connectors that can be separated by an operator without use of a tool, shall also be tested during and after disconnection. Any movable parts are to be put in the most unfavorable position.	No opening of PCE and the cover only can be removed by a trained personnel with the use of a tool.	P
	The test finger and the test pin are applied as above, without appreciable force, in every possible position, except that floor-standing equipment having a mass exceeding 40 kg is not tilted.	Considered	P



IEC/EN 62109-1, IEC/EN 62109-2			
Clause	Requirement – Test	Result – Remark	Verdict
	Equipment intended for building-in or rack mounting, or for incorporation in larger equipment, is tested with access to the equipment limited according to the method of mounting detailed in the installation instructions.	No a built-in or rack mounting equipment.	N/A
	c) Openings preventing the entry of the jointed test finger (Figure D-1 of Annex D) during test b) above, are further tested by means of straight unjointed test finger (Figure D-3 of Annex D), applied with a force of 30 N. If the unjointed finger enters, the test with the jointed finger is repeated except that the finger is applied using any necessary force up to 30 N.	No opening.	N/A
	d) In addition to a) – c) above, top surfaces of enclosure shall be tested with the IP3X probe of IEC 60529. The test probe shall not penetrate the top surface of the enclosure when probed from the vertical direction $\pm 5^\circ$ only.	No opening.	N/A
7.3.4.2.4	Service access areas	The PCE is not allowed to remove the covers during installation and maintenance when PCE energized.	P
7.3.4.3	Protection by means of insulation of live parts	See below	N/A
	Where the requirements of 7.3.4.2 are not met, live parts shall be provided with insulation if:	The requirements of 7.3.4.2 are met.	N/A
	– their working voltage is greater than the maximum limit of decisive voltage class A, or		N/A
	– for a DVC A or B circuit, protective separation from adjacent circuit of DVC C is not provided (see note “†” under Table 7)		N/A
7.3.5	Protection in case of direct contact		N/A
7.3.5.1	General		P
	Protection in case of direct contact is required to ensure that contact with live parts does not produce a shock hazard.	See below	P
	The protection against direct contact according to 7.3.4 is not required if the circuit contacted is separated from other circuits according to 7.3.2.3, and:	Considered	P
	– is of decisive voltage class A and complies with 7.3.5.2, or	Only DVC-A classified circuits can be touched directly, see also 7.3.5.2.	P
	– is provided with protective impedance according to 7.3.5.3, or		N/A
	– is limited in voltage according to 7.3.5.4		N/A



IEC/EN 62109-1, IEC/EN 62109-2			
Clause	Requirement – Test	Result – Remark	Verdict
	In addition to the measures as given in 7.3.5.2 to 7.3.5.4, it shall be ensured that in the event of error or polarity reversal of connectors no voltages that exceed DVC A can be connected into a circuit with protective separation. This applies for example to plug-in-sub-assemblies or other plug-in devices which can be plugged-in without the use of a tool (key) or which are accessible without the use of a tool.	Considered	P
	Conformity is checked by visual inspection and trial insertion.	Considered	P
7.3.5.2	Protection using decisive voltage class A	Considered	P
7.3.5.3	Protection by means of protective impedance	No such parts.	N/A
	Circuits and conductive parts do not require protection against direct contact if any connection to circuits of DVC-B or DVC-C is through protective impedance, and the accessible circuit or part is otherwise provided with protective separation from circuits of DVC-B or DVC-C according 7.3.3.		N/A
7.3.5.3.1	Limitation of current through protective impedance	No such parts.	N/A
	The current available through protective impedance to earth and between simultaneously accessible parts, measured at the accessible live parts, shall not exceed a value of 3,5 mA a.c. or 10 mA d.c. under normal and single-fault conditions.		N/A
7.3.5.3.2	Limitation of discharging energy through protective impedance	No such parts.	N/A
	The discharging energy available between simultaneously accessible parts protected by protective impedance shall not exceed the charging voltage and capacitance limits given in Table 9, which applies to both wet and dry locations, under normal and single fault conditions. Refer to figure 8.		N/A
7.3.5.4	Protection by means of limited voltages	No such parts.	N/A
	That portion of a circuit that has its voltage reduced to DVC-A by a voltage divider that complies with the following requirements, and that is otherwise provided with protective separation from circuits of DVC-B or DVC-C according to 7.3.3, does not require protection against direct contact.		N/A
	The voltage divider shall be designed so that under normal and single fault conditions, including faults in the voltage division circuit, the voltage across the output of the voltage divider does not exceed the limit for DVC-A.		N/A
	This type of protection shall not be used in case of protective class II or unearthed circuits, because it relies on protective earth being connected.		N/A
7.3.6	Protection against indirect contact		P
7.3.6.1	General	See below	P



IEC/EN 62109-1, IEC/EN 62109-2			
Clause	Requirement – Test	Result – Remark	Verdict
	Protection against indirect contact is required to prevent shock- hazardous current being accessible from conductive parts during an insulation failure. This protection shall comply with the requirements for protective class I (basic insulation plus protective earthing), class II (double or reinforced insulation) or class III (limitation of voltages)	The earthing metal enclosure is complied with protective class I and the circuit of communication is complied with protective class II for accessible communication ports.	P
	That part of a PCE meets the requirements of 7.3.6.2 and 7.3.6.3 is defined as protective class I	Considered	P
	That part of a PCE meets the requirements of 7.3.6.4 is defined as protective class II.	Considered	P
	That part of PCE which meets the requirements of decisive voltage class A and in which no hazardous voltages are derived, is defined as protective class III. No shock hazard is present in such circuits.		N/A
	Where protection against indirect contact is dependent on means provided during installation, the installation instructions shall provide details of the required means and shall indicate the associated hazards.	Considered	P
7.3.6.2	Insulation between live parts and accessible conductive parts	Considered	P
	Accessible conductive parts of equipment shall be separated from live parts by insulation meeting the requirements of Table 7 or by clearances as specified in 7.3.7.4 and creepages as specified in 7.3.7.5	The clearances specified in 7.3.7.4 and creepage specified in 7.3.7.5 are complied.	P
7.3.6.3	Protective class I – Protective bonding and earthing	See below	P
7.3.6.3.1	General		P
	Equipment of protective class I shall be provided with protective earthing, and with protective bonding to ensure electrical contact between accessible conductive parts and the means of connection for the external protective earthing conductor, except bonding is not required for:	See below	P
	a) accessible conductive parts that are protected by one of the measures in 7.3.5.2 to 7.3.5.4, or	DVC-A classified circuit is considered.	P
	b) accessible conductive parts are separated from live parts of DVC-B or -C using double or reinforced insulation.	Communication circuits are separated from live parts used double or reinforced insulation.	P
7.3.6.3.2	Requirements for protective bonding		P
	Electrical contact with the means of connection of the external protective earthing conductor shall be achieved by one or more of the following means:	See below	P
	a) through direct metallic contact;	The connection of external protective earthing conductor is direct metal contact via a terminal with screw.	P
	b) through other conductive parts which are not removed when the PCE or sub-units are used as intended ;	See above	N/A



IEC/EN 62109-1, IEC/EN 62109-2			
Clause	Requirement – Test	Result – Remark	Verdict
	c) through a dedicated protective bonding conductor;	Protective earthing terminal be used.	P
	d) through other metallic components of the PCE		N/A
	Where direct metallic contact is used and one or both of the parts involved is painted or coated, the paint or coating shall be removed in the area of contact, or reliably penetrated, to ensure metal to metal contact.	No painted and coated exsited.	P
	For moving or removable parts, hinges or sliding contacts designed and maintained to have a low resistance are examples of acceptable means if they comply with the requirements of 7.3.6.3.3.	No such parts.	N/A
	Metal ducts of flexible or rigid construction and metallic sheaths shall not be used as protective bonding conductors, unless the device or material has been investigated as suitable for protective bonding purposes.	No such parts.	N/A
7.3.6.3.3	Rating of protective bonding	The alternative of 7.3.6.3.5 is considered.	P
	Protective bonding shall withstand the highest thermal and dynamic stresses that can occur to the PCE item(s) concerned when they are subjected to a fault connecting live parts to accessible conductive parts. The protective bonding shall remain effective for as long as a fault to the accessible conductive parts persists or until an upstream protective device removes power from the part.		N/A
	Protective bonding shall meet following requirements:		N/A
	a) For PCE with an overcurrent protective device rating of 16 A or less, the impedance of the protective bonding means shall not exceed 0,1 Ω during or at the end of the test below.		N/A
	b) For PCE with an overcurrent protective device rating of more than 16 A, the voltage drop in the protective bonding test shall not exceed 2,5 V during or at the end of the test below.		N/A
	As alternative to a) and b) the protective bonding may designed according to the requirements for the external protective earthing conductor in 7.3.6.3.5, in which case no testing is required.	The alternative of 7.3.6.3.5 was considered.	P
	The impedance of protective bonding means shall be checked by passing a test current through the bond for a period of time as specified below. The test current is based on the rating of the overcurrent protection for the equipment or part of the equipment under consideration, as follows:		N/A



IEC/EN 62109-1, IEC/EN 62109-2			
Clause	Requirement – Test	Result – Remark	Verdict
	a) For pluggable equipment type A, the overcurrent protective device is that provided external to the equipment (for example, in the building wiring, in the mains plug or in an equipment rack);		N/A
	b) For pluggable equipment type B and fixed equipment, the maximum rating of the overcurrent protective device specified in the equipment installation instructions to be provided external to the equipment;		N/A
	c) For a circuit or part of the equipment for which an overcurrent protective device is provided as part of the equipment, the rating of the provided overcurrent device.		N/A
	Voltages are measured from the protective earthing terminal to all parts whose protective bonding means are being considered. The impedance of the protective earthing conductor is not included in the measurement. However, if the protective earthing conductor is supplied with the equipment, it is permitted to include the conductor in the test circuit but the measurement of the voltage drop is made only from the main protective earthing terminal to the accessible part required to be earthed.		N/A
	On equipment where the protective earth connection to a subassembly or to a separate unit is part of a cable that also supplies power to that subassembly or unit, the resistance of the protective bonding conductor in that cable is not included in the protective bond impedance measurements for the subassembly or separate unit, as shown in Figure 11. However, this option is only permitted if the cable is protected by a suitably rated protective device that takes into account the size of the conductor. Otherwise the impedance of the protective bonding conductor between the separate units is to be included, by measuring to the protective earthing terminal where the power source enters the first unit in the system, as shown in Figure 12.		N/A
7.3.6.3.3.1	Test current, duration, and acceptance criteria	The alternative of 7.3.6.3.5 was considered.	N/A
	The test current, duration of the test and acceptance criteria are as follows:		N/A
	a) For PCE with an overcurrent protective device rating of 16 A or less, the test current is 200% of the overcurrent protective device rating, but not less than 32 A, applied for 120s. The impedance of the protective bonding means during and at the end of the test shall not exceed 0,1 Ω.		N/A



IEC/EN 62109-1, IEC/EN 62109-2			
Clause	Requirement – Test	Result – Remark	Verdict
	b) For PCE with an overcurrent protective device rating of more than 16 A, the test current is 200% of the overcurrent protective device rating and the duration of the test is as shown in Table 10 below. The voltage drop in the protective bonding means, during and at the end of the test, shall not exceed 2,5 V.		N/A
	c) During and after the test, there shall be no melting, loosening, or other damage that would impair the effectiveness of the protective bonding means.		N/A
	The test current is derived from an a.c or d.c supply source, the output of which is not earthed.		N/A
	As an alternative to Table 10, where the time-current characteristic of the overcurrent protective device that limits the fault current in the protective bonding means is known because the device is either provided in the equipment or fully specified in the installation instructions, the test duration may be based on that specific device's time-current characteristic,. The tests are conducted for a duration corresponding to the 200% current value on the time-current characteristic.		N/A
7.3.6.3.4	Protective bonding impedance (routine test)	The alternative of 7.3.6.3.5 was considered.	N/A
	If the continuity of the protective bonding is achieved at any point by a single means only (for example a single conductor or single fastener), or if the PCE is assembled at the installation location, then the impedance of the protective bonding shall also be tested as a routine test. The test shall be as in 7.3.6.3.3, except for the following:		N/A
	<ul style="list-style-type: none"> ▪ the test current may be reduced to any convenient value greater than 10 A sufficient to allow measurement or calculation of the impedance of the protective bonding means: 		N/A
	<ul style="list-style-type: none"> ▪ the test duration may be reduced to no less than 2 s 		N/A
	For equipment subject to the type test in 7.3.6.3.3.1a), the impedance during the routine test shall not exceed 0,1Ω.		N/A
	For equipment subject to the type test in 7.3.6.3.3.1b) the impedance during the routine test shall not exceed 2,5 V divided by the test current required by 7.3.6.3.3.1b).		N/A
7.3.6.3.5	External protective earthing conductor	See below	P



IEC/EN 62109-1, IEC/EN 62109-2			
Clause	Requirement – Test	Result – Remark	Verdict
	A protective earthing conductor shall be connected at all times when power is supplied to PCE of protective class I. Unless local wiring regulations state otherwise, the protective earthing conductor cross-sectional area shall be determined from Table 11 or by calculation according to IEC 60364-5-54.	The protective earthing conductor is fixed permanently and the minimum cross-sectional area is 4mm ² for cable of phase and protective earthing. Only qualified personnel can install the protective earthing.	P
	If the external protective earthing conductor is routed through a plug and socket or similar means of disconnection, it shall not be possible to disconnect it unless power is simultaneously removed from the part to be protected.	The external protection earthing conductor just be removed when the power line is simultaneously removed from mains.	P
	The cross-sectional area of every external protective earthing conductor which does not form part of the supply cable or cable enclosure shall, in any case, be not less than:		N/A
	<ul style="list-style-type: none"> ▪ 2,5 mm² if mechanical protection is provided; 		N/A
	<ul style="list-style-type: none"> ▪ 4 mm² if mechanical protection is not provided. 	External a minimum cross-sectional area is 6mm ² conductors . The explanations are provided in the manual.	P
	For cord-connected equipment, provisions shall be made so that the external protective earthing conductor in the cord shall, in the case of failure of the strain-relief mechanism, be the last conductor to be interrupted.		N/A
7.3.6.3.6	Means of connection for the external protective earthing conductor	External protective earthing conductors connect to the enclosure body.	P
7.3.6.3.6.1	General		P
	<p>The means of connection for the external protective earthing conductor shall be located near the terminals for the respective live conductors. The means of connections shall be corrosion-resistant and shall be suitable for the connection of cables according to 7.3.6.3.5.</p> <p>The means of connection for the protective earthing conductor shall not be used as a part of the mechanical assembly of the equipment or for other connections.</p> <p>A separate means of connection shall be provided for each external protective earthing conductor. Connection and bonding points shall be so designed that their current-carrying capacity is not impaired by mechanical, chemical, or electrochemical influences. Where enclosures and/or conductors of aluminium or aluminium alloys are used, particular attention should be given to the problems of electrolytic corrosion.</p>	Considered	P
	The means of connection for the protective earthing conductor shall be permanently marked with:		P
	<ul style="list-style-type: none"> • symbol 7 of Annex C; or 		P



IEC/EN 62109-1, IEC/EN 62109-2			
Clause	Requirement – Test	Result – Remark	Verdict
	<ul style="list-style-type: none"> the colour coding green-yellow 		P
	Marking shall not be done on easily changeable parts such as screws.		P
7.3.6.3.7	Touch current in case of failure of the protective earthing conductor	See below	P
	The requirements of this sub-clause shall be satisfied to maintain safety in case of damage to or disconnection of the protective earthing conductor.		P
	For pluggable equipment type A, the touch current measured in accordance with 7.5.4 shall not exceed 3,5 mA a.c. or mA d.c.		N/A
	For all other PCE, one or more of the following measure shall be applied, unless the touch current measured in accordance with 7.5.4 using the test network of IEC 60990 test figure 4 shall not exceed 3,5 mA a.c. or 10 mA d.c.	See clause 7.5.4. The PCE touch current measured in accordance with 7.5.4 using the test network of IEC 60990 test figure 4 has not exceed 3,5 mA a.c. or 10 mA d.c.	P
	a) Permanently connected wiring, and:		N/A
	<ul style="list-style-type: none"> a cross-section of the protective earthing conductor of at least 10 mm² Cu or 16 mm² Al; or 		N/A
	<ul style="list-style-type: none"> automatic disconnection of the supply in case of discontinuity of the protective earthing conductor; or 		N/A
	<ul style="list-style-type: none"> provision of an additional terminal for a second protective earthing conductor of the same cross-sectional area as the original protective earthing conductor and installation instruction requiring a second protective earthing conductor to be installed or 		N/A
	b) Connection with an industrial connector according to IEC 60309 and a minimum protective earthing conductor cross-section of 2,5 mm ² as part of a multi-conductor power cable. Adequate strain relief shall be provided.		N/A
	In addition, the caution symbol 15 of Annex C shall be fixed to the product and the installation manual shall provide details of the protective earthing measures required in the installation as required in 5.3.2.		N/A
	When it is intended and allowed to connect two or more PCEs in parallel using one common PE conductor, the above touch current requirements apply to the maximum number of the PCEs to be connected in parallel, unless one of the measures in a)		N/A
	or b) above is used. The maximum number of parallel PCEs is used in the testing and has to be stated in the installation manual.		N/A



IEC/EN 62109-1, IEC/EN 62109-2			
Clause	Requirement – Test	Result – Remark	Verdict
7.3.6.4	Protective Class II – Double or Reinforced Insulation	See below	P
	Equipment or parts of equipment designed for protective class II shall have insulation between live parts and accessible surfaces in accordance with 7.3.4.3. The following requirements also apply:	Accessible communication circuits and hazardous live parts were separated by reinforced insulation.	P
	<ul style="list-style-type: none"> equipment designed to protective class II shall not have means of connection for the external protective earthing conductor. However this does not apply if the external protective earthing conductor is passed through the equipment to equipment series-connected beyond it. In the latter event, the external protective earthing conductor and its means for connection shall be insulated with basic insulation from the accessible surface of the equipment and from circuits that employ protective separation, extra-low voltage, protective impedance and limited discharging energy, according to 7.3.5. This basic insulation shall correspond to the rated voltage of the series-connected equipment; 		P
	<ul style="list-style-type: none"> metal-encased equipment of protective class II may have provision on its enclosure for the connection of an equipotential bonding conductor; 		N/A
	<ul style="list-style-type: none"> equipment of protective class II may have provision for the connection of an earthing conductor for functional reasons or for damping of overvoltages; it shall, however, be insulated as though it is a live part; 		N/A
	<ul style="list-style-type: none"> equipment employing protective class II shall be marked according to 5.1.8. 		N/A
7.3.7	Insulation Including Clearance and Creepage Distance		P
7.3.7.1	General	See below	P
	This subclause gives minimum requirements for insulation, based on the principles of IEC 60664.	Considered	P
	Manufacturing tolerances shall be taken into account during measurement of creepage, clearance, and insulation distance in the PCE.	Considered	P
	Insulation shall be selected after consideration of the following influences:	Considered	P
	<ul style="list-style-type: none"> pollution degree 	PD2 for internal environment, PD3 for external environment.	P
	<ul style="list-style-type: none"> overvoltage category 	The mains circuits: OVC III The PV Array circuits: OVC II	P
	<ul style="list-style-type: none"> supply earthing system 	TN system	P
	<ul style="list-style-type: none"> insulation voltage 	Considered	P
	<ul style="list-style-type: none"> location of insulation 	Considered	P



IEC/EN 62109-1, IEC/EN 62109-2			
Clause	Requirement – Test	Result – Remark	Verdict
	<ul style="list-style-type: none"> type of insulation 	Considered	P
	Compliance of insulation, creepage distances, and clearance distances, shall be verified by measurement or visual inspection, and the tests of 7.5.	Considered	P
7.3.7.1.1	Pollution degree		P
	Insulation, especially when provided by clearances and creepage distances, is affected by pollution that occurs during the expected lifetime of the PCE. The pollution degree rating of the PCE or section of the PCE to be used in judging the requirements of this section shall be the pollution degree determined according to 6.1 and 6.2.	PD2 for internal environment, PD3 for external environment.	P
7.3.7.1.2	Overvoltage category and Impulse withstand voltage rating		P
	The concept of overvoltage categories is applied to each separate circuit in the PCE, including mains circuits, PV circuits, and other circuits, whether connected to or isolated from the mains and PV circuits, as follows:		P
	a) For equipment or circuits energized from the mains, four categories are considered:		P
	<ul style="list-style-type: none"> category IV applies to equipment permanently connected at the origin of an installation(upstream of the main distribution board). Examples are electricity meters, primary overcurrent protection equipment and other equipment connected directly to outdoor open lines 		N/A
	<ul style="list-style-type: none"> category III applies to fixed equipment downstream of, and including, the main distribution board. Examples are switchgear and other equipment in an industrial installation; 		P
	<ul style="list-style-type: none"> category II applies to equipment not permanently connected to the installation. Examples are appliances, portable tools and other plug-connected equipment; 		N/A
	<ul style="list-style-type: none"> category I applies to equipment connected to a circuit where measures have been taken to reduce transient overvoltages to a low level. 		N/A
	Impulse withstand voltage ratings for the mains circuit are assigned based on the above OVC and on the mains system voltage, as in 7.3.7.1.4.	See clause 7.3.7.1.4.	P
	b) For PV circuits in general, Overvoltage Category II is assumed, and impulse withstand voltage ratings for the PV circuit are assigned based on the PV system voltage as in 7.3.7.1.4, but the minimum impulse voltage to be used is 2 500 V.	See clause 7.3.7.1.4.	P



IEC/EN 62109-1, IEC/EN 62109-2			
Clause	Requirement – Test	Result – Remark	Verdict
	c) For PCE with galvanic isolation between the mains and PV circuits, the impulse voltage withstand ratings of the mains and PV circuits are determined as in a) and b) above, and then the effect of reduction of OVC across the isolation is evaluated as follows:	No-isolation inverter.	N/A
	– The magnitude of impulses from the mains circuit on the PV circuit is determined by reducing the OVC of the mains circuit by one level, and determining the resulting impulse voltage withstand rating based on mains system voltage.		N/A
	– The rating to be used on the PV circuit is the higher of the value in b) and the value calculated above.		N/A
	– The magnitude of impulses from the PV circuit on the mains circuit is determined by reducing the OVC of the PV circuit by one level, and determining the resulting impulse voltage withstand rating based on PV system voltage.		N/A
	– The rating to be used on the mains circuit is the higher of the value in a) and the value calculated above.		N/A
	d) For PCE not providing galvanic isolation between the mains and PV circuits, the impulse withstand voltage ratings of the mains and PV circuits are determined as in a) and b) above, and the higher of the two impulse withstand voltage ratings is used for the entire combined circuit. For circuits connected to the combined circuit without galvanic isolation, the impulse withstand voltage rating of the combined circuit applies.	The higher impulse withstand voltage ratings between the mains circuits and PV circuits were used for the entire combined circuit.	P
	e) For other circuits the impulse withstand voltage rating is the most severe rating determined by the relationship of the circuit under consideration to the PV and mains circuits, according to the following:	Considered.	P
	• for circuits connected to the mains without galvanic isolation, the impulse withstand voltage rating of the mains circuit applies;		P
	• for circuits connected to the PV circuit without galvanic isolation, the impulse withstand voltage rating of the PV circuit applies;		P



IEC/EN 62109-1, IEC/EN 62109-2			
Clause	Requirement – Test	Result – Remark	Verdict
	<ul style="list-style-type: none"> where isolation is provided by means of isolation transformers, optocouplers, or similar galvanic isolation devices, between a considered circuit and an adjacent mains or PV circuit, the impulse withstand voltage rating of the considered circuit is reduced by one level from that of the adjacent circuit; if more than one adjacent circuit is involved, the highest resulting impulse withstand voltage rating applies. 		P
	f) The overvoltage categories determined as above apply from circuits to earth. The overvoltage category that applies to functional insulation within each circuit is one category lower (less severe) than the overvoltage category that applies from the circuit to earth.	Considered	P
	g) Application of means to reduce impulse voltages: For basic and functional insulation, if transient reduction means are provided which reduce impulses to lower values, insulation may be designed for the reduced impulse levels. The reduced values to be used are the highest impulses occurring in the testing of 7.5.1.	No such parts.	N/A
	If such devices are used to reduce the values for design of Basic insulation, and the devices can be damaged by overvoltages or repeated impulses, thus decreasing their ability to reduce impulses, they shall be monitored and an indication of their status provided.		N/A
7.3.7.1.3	Supply earthing systems		P
	Three basic types of earthing system are described in IEC 60364-1. They are:	See below.	P
	<ul style="list-style-type: none"> TN system: has one point directly earthed, the accessible conductive parts of the installation being connected to that point by protective conductors. Three types of TN systems, TN-C, TN-S and TN-C-S, are defined according to the arrangement of the neutral and protective conductor. 	Considered	P
	<ul style="list-style-type: none"> TT system: has one point directly earthed, the accessible conductive parts of the installation being connected to earth electrodes electrically independent of the earth electrodes of the power system; 		N/A
	<ul style="list-style-type: none"> IT system: has all live parts isolated from earth or one point connected to earth through an impedance, the accessible conductive parts of the installation being earthed independently or collectively to the earthing system. 		N/A
7.3.7.1.4	Insulation voltages		P



IEC/EN 62109-1, IEC/EN 62109-2			
Clause	Requirement – Test	Result – Remark	Verdict
	Table 12 makes use of the circuit system voltage and overvoltage category to define the impulse withstand voltage and the temporary overvoltage.	Considered	P
7.3.7.2	Insulation between a circuit and its surroundings	Considered	P
7.3.7.2.1	Basic, supplementary, and reinforced insulation between a circuit and its surroundings shall be designed according to: the impulse voltage; or the temporary overvoltage; or the working voltage of the circuit. System voltage in column 1 is:	Considered	P
	• in TN and TT systems: the r.m.s. value of the rated voltage between a phase and earth;		P
	• in three-phase IT systems:		N/A
	– for determination of impulse voltage, the r.m.s. value of the rated voltage between a phase and an artificial neutral point (an imaginary junction of equal impedances from each phase);		N/A
	– for determination of temporary overvoltage, the r.m.s. value of the rated voltage between phases;		N/A
	• In single-phase IT systems: the r.m.s. value of the rated voltage between phase conductors.		N/A
7.3.7.2.2	Clearances and solid insulation between circuits connected directly to the mains and their surroundings shall be designed according to the impulse voltage, temporary overvoltage, or working voltage, whichever gives the most severe requirement.	Considered	N/A
7.3.7.2.3	Circuits other than mains circuits		P
	Clearances and solid insulation between circuits other than the mains and their surroundings shall be designed according to impulse voltage and recurring peak voltage, according to the following:		P
	– the system voltage is – for PV circuits, the max rated PV open circuit voltage; – for other circuits, the working voltage;		P
	– the impulse voltage is determined from Table 12, using the system voltage above and according to 7.3.7.1.2;		P
	– the working voltage or the impulse voltage, whichever gives the more severe requirement, determines the design of the clearances and solid insulation.		P



IEC/EN 62109-1, IEC/EN 62109-2			
Clause	Requirement – Test	Result – Remark	Verdict
7.3.7.2.4	Insulation between two circuits shall be designed according to the following: a) for clearances and insulation, the requirements are determined by the circuit having the higher impulse voltages; b) for creepages, r.m.s. working voltage across the insulation determines the requirements.		P
7.3.7.3	Functional insulation is permitted, the voltage used for insulation requirements is determined.		P
7.3.7.4	Clearance distances		P
7.3.7.4.1	Table 13 defines the minimum clearance distances required to provide functional, basic, or supplementary insulation.	Considered	P
	To determine clearances for reinforced insulation from Table 13, the value corresponding to the next higher impulse voltage, or 1,6 times the temporary overvoltage, or 1,6 times the working voltage shall be used, whichever results in the most severe requirement.	See appended table 7.3.7	P
7.3.7.4.2	Electric field homogeneity	Considered	P
	Homogeneous electric field distribution within impulse voltage is equal to or greater than 6000V circuits.		P
7.3.7.4.3	Clearance to conductive enclosures		P
	The clearance between any non-insulated live part and the walls of a metal enclosure shall be in accordance with 7.3.7.4.1 following the deformation tests of 13.7.	Considered	P
	If the design clearance is at least 12,7 mm and the clearance required by 7.3.7.4.1 does not exceed 8 mm, the deformation tests may be omitted.	See clause 13.7.2	P
7.3.7.5	Creepage distances		P
7.3.7.5.1	General	See below.	P
	Creepage distances shall be verified by measurement or inspection, according to Table 14. For reinforced insulation, the distances in Table 14 shall be doubled.	Considered	P
7.3.7.5.2	Voltage		P
	Table 14 is the r.m.s. value of the working voltage across the creepage distance. Interpolation is permitted.	See appended Table 7.3.7	P
7.3.7.5.3	Materials		P



IEC/EN 62109-1, IEC/EN 62109-2			
Clause	Requirement – Test	Result – Remark	Verdict
	<p>Insulating materials are classified into four groups corresponding to their comparative tracking index (CTI) when tested according to 6.2 of IEC 60112</p> <ul style="list-style-type: none"> • Insulating material group I CTI \geq 600; • Insulating material group II 600 CTI \geq 400; • Insulating material group IIIa 400 CTI \geq 175; • Insulating material group IIIb 175 CTI \geq 100. <p>Creepage distances on printed wiring boards (PWBs) exposed to pollution degree 3 environmental conditions shall be determined based on Table 14 Pollution degree 3 under "Other insulators".</p>	Considered	P
	If the creepage distance is ribbed, then the creepage distance of insulating material of group I may be applied when using insulating material of group II and the creepage distance of insulating material of group II may be applied when using insulating material of group III.		N/A
	Except at pollution degree 1 the ribs shall be 2 mm high at least. The spacing of the ribs shall equal or exceed the dimension 'X' in Annex A Table A.1.	Considered	P
	For inorganic insulating materials, for example glass or ceramic, which do not track, the creepage distance may equal the associated clearance, as determined from Table 13.	Considered	P
7.3.7.6	Coating	No such parts.	N/A
	A coating may be used to provide insulation, to protect a surface against pollution, and to allow a reduction in creepage and clearance distances		N/A
7.3.7.7	PWB spacings for functional insulation		P
	<p>Functional insulation on a PWB which do not comply with 7.3.7.4 and 7.3.7.5 are permitted when all the following:</p> <ul style="list-style-type: none"> • the PWB has flammability rating of V-0 (see IEC 60695-11-10); and • the PWB base material has a minimum CTI of 175; and • the equipment complies with the PWB short-circuit test (see 4.4.4.14). <p>Working voltages less than 80 V (r.m.s.) or 110 V (recurring peak) are covered with a suitable coating. The coating is not required to be tested.</p>	Considered	P
7.3.7.8	Solid insulation		P
7.3.7.8.1	General	See below	P



IEC/EN 62109-1, IEC/EN 62109-2			
Clause	Requirement – Test	Result – Remark	Verdict
	Materials selected for solid insulation shall be able to withstand the stresses occurring in the application. These include mechanical, electrical, thermal and climatic stresses which are to be expected in normal use. Insulation materials shall also be resistant to ageing during the expected lifetime of the PCE.	Considered	P
	Tests shall be performed on components and subassemblies using solid insulation, in order to ensure that the insulation performance has not been compromised by the design or manufacturing process.	Considered	P
	Components that comply with a relevant component standard that provide equivalent requirements to those of this standard do not require separate evaluation. Assemblies containing such components shall be tested according to the requirements of this standard.	Considered	P
7.3.7.8.2	Requirements for electrical withstand capability of solid insulation		P
7.3.7.8.2.1	Basic, supplemental, reinforced, and double insulation	See below	P
	Solid insulation shall withstand the applicable impulse withstand voltage test according to 7.5.1 and the a.c. or d.c. voltage test according to 7.5.2. In addition, double and reinforced insulation shall withstand the partial discharge test according to 7.5.3, if the recurring peak working voltage across the insulation is greater than 700 V and the voltage stress on the insulation is greater than 1 kV/mm.	See clause 7.5.1, 7.5.2 and 7.5.3.	P
7.3.7.8.2.2	Functional insulation		P
	Functional insulation shall comply with the requirements of 7.3.7.3. Testing is not required.	Considered	P
7.3.7.8.3	Thin sheet or tape material		P
7.3.7.8.3.1	General		P
	Insulation consisting of thin (less than 0,7 mm) sheet or tape materials is permitted, provided that it is protected from damage and is not subject to mechanical stress under normal use.	The transformer primary and secondary windings were separated by thin insulation sheet.	P
	Thin sheet or tape material shall comply with the requirements for solid insulation in 7.3.7.8.1 and with 7.3.7.8.3.2 or 7.3.7.8.3.3 as applicable.		P
7.3.7.8.3.2	Material thickness not less than 0,2 mm		P
	<ul style="list-style-type: none"> Basic or supplementary insulation shall consist of at least one layer of material, and shall meet the impulse and a.c. or d.c. voltage test requirements of 7.3.7.8.2.1 for basic or supplementary insulation. 		P



IEC/EN 62109-1, IEC/EN 62109-2			
Clause	Requirement – Test	Result – Remark	Verdict
	<ul style="list-style-type: none"> Double insulation shall consist of at least two layers of material. Each layer shall meet the impulse and a.c. or d.c. voltage test requirements of 7.3.7.8.2.1 for basic insulation, and the partial discharge requirements of 7.3.7.8.2.1. The two or more layers together shall meet the impulse and a.c. or d.c. voltage test requirements of 7.3.7.8.2.1 for double insulation. 		P
	<ul style="list-style-type: none"> Reinforced insulation shall consist of a single layer of material, which will meet the impulse, a.c. or d.c. voltage, and partial discharge test requirements 7.3.7.8.2.1 for reinforced insulation. 		P
7.3.7.8.3.3	Material thickness less than 0,2 mm		P
	<ul style="list-style-type: none"> Basic or supplementary insulation shall consist of at least one layer of material, and shall meet the impulse and a.c. or d.c. voltage test requirements of 7.3.7.8.2.1 for basic or supplementary insulation. 		P
	<ul style="list-style-type: none"> Double insulation shall consist of at least three layers of material. Each layer shall meet the impulse and a.c. or d.c. voltage test requirements of 7.3.7.8.2.1 for basic insulation. Any two layers together shall meet the impulse, a.c. or d.c. voltage, and partial discharge test requirements of 7.3.7.8.2.1 for double insulation. 		P
	<ul style="list-style-type: none"> Reinforced insulation consisting of a single layer of material less than 0,2 mm thick is not permitted. 		P
7.3.7.8.3.4	Compliance		P
	Compliance is checked by the tests described in 7.5.1 to 7.5.3 applied according to 7.3.7.8.2. When a component or sub-assembly makes use of thin sheet insulating materials, it is permitted to perform the tests on the component rather than on the material.	See clause 7.5.1, 7.5.2 and 7.5.3.	P
7.3.7.8.4	Printed wiring boards (PWBs)	Considered.	P
7.3.7.8.4.1	General		P
	Insulation between conductor layers in PWBs, shall meet the requirements for solid insulation in 7.3.7.8. For the inner layers of multi-layer PWBs, the insulation between adjacent tracks on the same layer shall be treated as either:		P
	<ul style="list-style-type: none"> a creepage distance for pollution degree 1 and a clearance as in air (see Annex A, figure A.13); or 		P
	<ul style="list-style-type: none"> as solid insulation, in which case it shall meet the requirements of 7.3.7.8. 		P
7.3.7.8.4.2	Use of coating materials	No coating materials.	N/A



IEC/EN 62109-1, IEC/EN 62109-2			
Clause	Requirement – Test	Result – Remark	Verdict
	A coating material used to provide a microenvironment or to provide functional, basic, supplementary and reinforced insulation shall meet the requirement as specified below.		N/A
	<ul style="list-style-type: none"> Type 1 protection improves the microenvironment (PollutionDegree) of the parts under protection. The clearance and creepage distance of Table 13 and Table 14 for pollution degree 1 apply under the protection. 		N/A
	<ul style="list-style-type: none"> Type 2 protection is considered to be similar to solid insulation. Under the protection, the requirements for solid insulation specified in 7.3.7.8 are applicable and spacings shall not be less than those specified in Table 1 of IEC 60664-3. 		N/A
	The coating material used to provide Type 1 and Type 2 protection shall be check by a type test on representative PWB's, conducted according to IEC 60664-3 Clause 5.		N/A
7.3.7.8.5	Wound components		P
	Varnish or enamel insulation of wires shall not be used for basic, supplementary, double or reinforced insulation.	Considered.	P
	The component itself shall pass the requirements given in 7.3.7.8.1 and 7.3.7.8.2. If the component has reinforced or double insulation, the voltage test in 7.5.2 shall be performed as a routine test.	Considered.	P
7.3.7.8.6	Potting materials		P
	A potting material may be used to provide solid insulation or to act as a coating to protect against pollution. it shall comply with the requirements of 7.3.7.8.1 and 7.3.7.8.2. or the requirements for Type 1 protection in 7.3.7.8.4.2 apply.	Considered.	P
7.3.7.9	Insulation requirements above 30 kHz	Considered.	P
7.3.8	Residual Current-operated protective (RCD) or monitoring (RCM) device compatibility		N/A
	RCD and RCM are used to provide protection against insulation faults in some domestic and industrial installations, additional to that provided by the installed equipment.		N/A
7.3.9	Capacitor discharge	See below.	P
7.3.9.1	Operator access area		P
	Equipment shall be so designed that there is no risk of electric shock in operator access areas from charge stored on capacitors after disconnection of the PCE.	The operator is instructed to the installation shall be performed by qualified technician. The pins of connector cannot be touched by test finger due to the design protection.	P
7.3.9.2	Service access areas		P



IEC/EN 62109-1, IEC/EN 62109-2			
Clause	Requirement – Test	Result – Remark	Verdict
	Capacitors located behind panels that are removable for servicing, installation, or disconnection shall present no risk of electric shock or energy hazard from charge stored on capacitors after disconnection of the PCE.	The symbol 21 of Annex C with 5min was provided on the label.	P
7.3.10 of IEC 62109-2	Additional requirements for stand-alone inverters	Grid-interactive inverter.	N/A
	Depending on the supply earthing system that a stand-alone inverter is intended to be used with or to create, the output circuit may be required to have one circuit conductor bonded to earth to create a grounded conductor and an earthed system.		N/A
	The means used to bond the grounded conductor to protective earth may be provided within the inverter or as part of the installation. If not provided integral to the inverter, the required means shall be described in the installation instructions as per 5.3.2.8.		N/A
	The means used to bond the grounded conductor to protective earth shall comply with the requirements for protective bonding in Part 1, except that if the bond can only ever carry fault currents in stand-alone mode, the maximum current for the bond is determined by the inverter maximum output fault current.		N/A
	Output circuit bonding arrangements shall ensure that in any mode of operation, the system only has the grounded circuit conductor bonded to earth in one place at a time. Switching arrangements may be used, in which case the switching device used is to be subjected to the bond impedance test along with the rest of the bonding path.		N/A
	Inverters intended to have a circuit conductor bonded to earth shall not impose any normal current on the bond except for leakage current.		N/A
	Outputs that are intentionally floating with no circuit conductor bonded to ground, must not have any voltages with respect to ground that are a shock hazard in accordance with Clause 7 of Parts 1 and 2. The documentation for the inverter shall indicate that the output is floating as per 5.3.2.8.		N/A
7.3.11 of IEC 62109-2	Functionally grounded arrays	No such parts.	N/A
	All PV conductors in a functionally grounded array shall be treated as being live parts with respect to protection against electric shock.		N/A
7.4	Protection against energy hazards		P
7.4.1	Determination of hazardous energy level		P
	A hazardous energy level is considered to exist if	See below	P
	a) The voltage is 2 V or more, and power available after 60 s exceeds 240 VA.	Considered	P



IEC/EN 62109-1, IEC/EN 62109-2			
Clause	Requirement – Test	Result – Remark	Verdict
	b) The stored energy in a capacitor is at a voltage. U of 2 V or more, and the stored energy. E, calculated from the following equation, exceeds 20J: $E = 0,5 CU^2$	Considered	P
7.4.2	Operator Access Areas	See below	P
	Equipment shall be so designed that there is no risk of energy hazard in operator access areas from accessible circuits.	All hazardous energy parts were enclosed within earthed metal enclosure.	P
7.4.3	Services Access Areas		P
	Energy storage devices located behind panels that are removable for servicing, installation or disconnection shall present no risk of electric energy hazard from charge stored after disconnection of the PCE.	See below	P
	Energy storage devices within a PCE shall be discharged to an energy level less than 20 J, as in 7.4.1, within 10 s after the removal	The symbol 21 of Annex C was provided on the label.	P
7.5	Electrical test related to shock hazard		P
7.5.1	Impulse voltage test (type test)		P
	The impulse voltage test is performed with voltage having a 1.2/50µs waveform. Test is performed using the impulse withstand voltage listed in Table 16.	See below	P
	The impulse voltage test and is successfully passed if no puncture, flashover, or sparkover occurs.	See appended Table 7.5	P
7.5.2	Dielectric strength test		P
7.5.2.2	The values of the test voltage are determined from column 2 or 3 of Table 17 or Table 18.	See below	P
	The voltage test shall be performed with a sinusoidal voltage at 50 Hz or 60 Hz. If the circuit contains capacitors the test may be performed with a d.c. voltage of a value equal to the peak value of the specified a.c. voltage.	See appended Table 7.5	P
7.5.2.3	Humidity pre-conditioning		P
	For type tests on PCE for which wet locations requirements apply, according to 6.1, the humidity pre-conditioning of 4.5 shall be performed immediately prior to the voltage test.	Considered	P
7.5.2.4	Performing the voltage test.		P
	a) between accessible conductive part and each circuit sequentially.	Considered	P
	b) Test between each considered circuit sequentially and the other adjacent circuits connected together.	Considered	P
	c) Test between DVC A circuit and each adjacent circuit sequentially	Considered	P
	The tests shall be performed with the PCE fully assembled, and all covers in place and all doors of the enclosure closed.		P



IEC/EN 62109-1, IEC/EN 62109-2			
Clause	Requirement – Test	Result – Remark	Verdict
	Wherever practicable, individual components forming part of the insulation under test, for example interference suppression capacitors, should not be disconnected or bridged before the test.		P
	Where the PCE is covered totally or partly by a non-conductive accessible surface, a conductive foil to which the test voltage is applied shall be wrapped around this surface for testing.		P
7.5.2.5	Duration of the a.c. or d.c. voltage test		P
	The duration of the test shall be at least 60 s at full voltage for the type test and 1 s for the routine test.	Considered	P
7.5.2.6	Verification of the a.c. or d.c. voltage test		P
	The test is successfully passed if no electrical breakdown occurs and there is no abnormal current flow during the test.	Considered	P
7.5.3	Partial discharge test		N/A
	the partial discharge test shall confirm that the solid insulation used within devices applied for protective separation of electrical circuits remains partialdischarge- free within the specified voltage range (see Table 19).		N/A
7.5.4	Touch current measurement (type test)		P
	The touch current shall be measured if required by 7.3.6.3.7 and shall not be greater than 3.5 mA a.c. or 10 mA d.c. or special measures of protection as given in 7.3.6.3.7 are required.	See 7.3.6.3.7	P
	For type tests on PCE for which wet locations requirements apply according to 6.1, the humidity pre-conditioning of 4.5 shall be performed immediately prior to the touch current test.	See 7.3.6.3.7	P
7.5.5	Equipment with multiple sources of supply		P
	Hazards, within the meaning of this standard, shall not be present under normal or single fault conditions due to the presence of multiple sources of supply. Information shall be provided with the equipment indicating the presence of multiple sources of supply and giving disconnection procedures.	Considered	P

8	PROTECTION AGAINST MECHANICAL HAZARDS		P
8.1	General		P
	Operation shall not lead to a mechanical HAZARD in NORMAL CONDITION or SINGLE FAULT CONDITION. Edges, projections, corners, openings, guards, handles and the like, that are accessible to the operator shall be smooth and rounded so as not to cause injury during normal use of the equipment.	No mechanical hazards under the normal or single fault condition.	P
	Conformity is checked as specified in 8.2 to 8.6.		P
8.2	Moving parts		N/A



IEC/EN 62109-1, IEC/EN 62109-2			
Clause	Requirement – Test	Result – Remark	Verdict
	Moving parts shall not be able to crush, cut or pierce parts of the body of an OPERATOR likely to contact them, nor severely pinch the OPERATOR's skin. Hazardous moving parts of equipment, that is moving parts which have the potential to cause injury, shall be so arranged, enclosed or guarded as to provide adequate protection against the risk of personal injury.	No moving parts.	N/A
8.2.1	Protection of service persons	No mechanical hazards for service persons.	P
	Protection shall be provided such that unintentional contact with hazardous moving parts is unlikely during servicing operations. If a guard over a hazardous moving part may need to be removed for servicing, the marking of symbol 15 of Table D-1 shall be applied on or near the guard.		P
8.3	Stability		N/A
	Equipment and assemblies of equipment not secured to the building structure before operation shall be physically stable in NORMAL USE.		P
8.4	Provisions for lifting and carrying		N/A
	If carrying handles or grips are fitted to, or supplied with, the equipment, they shall be capable of withstanding a force of four times the weight of the equipment.	PCE for wall mounting.	N/A
	Equipment or parts having a mass of 18 kg or more shall be provided with a means for lifting and carrying or directions shall be given in the manufacturer's documentation.		N/A
8.5	Wall mounting		P
	Mounting brackets on equipment intended to be mounted on a wall or ceiling shall withstand a force of four times the weight of the equipment.	Considered.	P
8.6	Expelled parts		N/A
	Equipment shall contain or limit the energy of parts that could cause a HAZARD if expelled in the event of a fault.	No such parts.	N/A

9	PROTECTION AGAINST FIRE HAZARDS		P
9.1	Resistance to fire		P
	This subclause specifies requirements intended to reduce the risk of ignition and the spread of flame, both within the equipment and to the outside, by the appropriate use of materials and components and by suitable construction.	PCE employed with metal enclosure reduce the risk of ignition and the spread of flame.	P
9.1.1	Reducing the risk of ignition and spread of flame		P
	For equipment or a portion of equipment, there are two alternative methods of providing protection against ignition and spread of flame that could affect materials, wiring, wound components and electronic components such as integrated circuits, transistors, thyristors, diodes, resistors and capacitors.	Considered.	P
9.1.2	Conditions for a fire enclosure		P



IEC/EN 62109-1, IEC/EN 62109-2			
Clause	Requirement – Test	Result – Remark	Verdict
	A FIRE ENCLOSURE is required for equipment or parts of equipment for which Method 2 is not fully applied and complied with.	Fire enclosure is used.	P
9.1.2.1	Parts requiring a fire enclosure		P
	Except where Method 2 is used, or as permitted in 9.1.2.2, the following are considered to have a risk of ignition and, therefore, require a FIRE ENCLOSURE:	Considered.	P
	– components in PRIMARY CIRCUITS	Considered.	P
	– components in SECONDARY CIRCUITS supplied by power sources which exceed the limits for a LIMITED POWER SOURCE as specified in 9.2;	Considered.	P
	– components in SECONDARY CIRCUITS supplied by a LIMITED POWER SOURCE as specified in 9.2, but not mounted on a material of FLAMMABILITY CLASS V-1;	No such devices.	N/A
	– components within a power supply unit or assembly having a limited power output complying with the criteria for a LIMITED POWER SOURCE as specified in 9.2, including overcurrent protective devices, limiting impedances, regulating networks and wiring, up to the point where the LIMITED POWER SOURCE output criteria are met;	No such devices.	N/A
	– components having unenclosed arcing parts, such as open switch and relay contacts and commutators, in a circuit at HAZARDOUS VOLTAGE or at a HAZARDOUS ENERGY LEVEL; and	No such devices.	N/A
	– insulated wiring, except as permitted in 9.1.2.2.	Considered.	P
9.1.2.2	Parts not requiring a fire enclosure	Component within fire enclosure.	N/A
9.1.3	Materials requirements for protection against fire hazard		P
9.1.3.1	General		P
	ENCLOSURES, components and other parts shall be so constructed, or shall make use of such materials, that the propagation of fire is limited.	Considered.	P
9.1.3.2	Materials for fire enclosures		P
	If an enclosure material is not classified as specified below, a test may be performed on the final enclosure or part of the enclosure, in which case the material shall additionally be subjected to periodic SAMPLE testing.	PCE with metal fire enclosure.	P
9.1.3.3	Materials for components and other parts outside fire enclosures	Considered.	P



IEC/EN 62109-1, IEC/EN 62109-2			
Clause	Requirement – Test	Result – Remark	Verdict
	Except as otherwise noted below, materials for components and other parts (including MECHANICAL ENCLOSURES, ELECTRICAL ENCLOSURES and DECORATIVE PARTS); located outside FIRE ENCLOSURES, shall be of FLAMMABILITY CLASS HB.	Considered.	P
9.1.3.4	Materials for components and other parts inside fire enclosures		P
9.1.3.5	Materials for air filter assemblies		N/A
9.1.4	Openings in fire enclosures	No openings in fire enclosure.	N/A
9.1.4.1	General		N/A
	For equipment that is intended to be used or installed in more than one orientation as specified in the product documentation, the following requirements apply in each orientation.	Vertical mounting only.	N/A
	These requirements are in addition to those in the following sections:		N/A
	– 7.3.4, Protection against direct contact;		N/A
	– 7.4, Protection against energy hazards;		N/A
	– 13.5, Openings in enclosures		N/A
9.1.4.2	Side openings treated as bottom openings		P
9.1.4.3	Openings in the bottom of a fire enclosure	No openings in the bottom of a fire enclosure.	N/A
	The bottom of a FIRE ENCLOSURE or individual barriers, shall provide protection against emission of flaming or molten material under all internal parts, including partially enclosed components or assemblies, for which Method 2 of 9.1.1 has not been fully applied and complied with.		N/A
9.1.4.4	Equipment for use in a CLOSED ELECTRICAL OPERATING AREA	PCE did not use for closure electrical operating area.	N/A
	The requirements of 9.1.4.3 do not apply to FIXED EQUIPMENT intended only for use in a CLOSED ELECTRICAL OPERATING AREA and to be mounted on a concrete floor or other non-combustible surface. Such equipment shall be marked as follows:		N/A
	WARNING: FIRE HAZARD SUITABLE FOR MOUNTING ON CONCRETE OR OTHER NON-COMBUSTIBLE SURFACE ONLY		N/A
9.1.4.5	Doors or covers in fire enclosures	No any door or covers in fire enclosure.	N/A
9.1.4.6	Additional requirements for openings in transportable equipment		N/A
9.2	LIMITED POWER SOURCES	No LPS circuits.	N/A
9.2.1	General		N/A
9.2.2	Limited power source tests		N/A
9.3	Short-circuit and overcurrent protection		N/A
9.3.1	General		N/A



IEC/EN 62109-1, IEC/EN 62109-2			
Clause	Requirement – Test	Result – Remark	Verdict
	The PCE shall not present a hazard, under short-circuit or overcurrent conditions at any port, including phase-to-phase, phase-to-earth and phase-to-neutral, and adequate information shall be provided to allow proper selection of external wiring and external protective devices.		N/A
9.3.2	Protection against short-circuits and overcurrents shall be provided for all input circuits, and for output circuits that do not comply with the requirements for limited power sources in 9.2, except for circuits in which no overcurrent hazard is presented by short-circuits and overloads.		N/A
9.3.3	Protective devices provided or specified shall have adequate breaking capacity to interrupt the maximum short circuit current specified for the port to which they are connected. If protection that is provided integral to the PCE for an input port is not rated for the short-circuit current of the circuit in which it is used, the installation instructions shall specify that an upstream protective device, rated for the prospective short-circuit current of that port, shall be used to provide backup protection.		N/A
9.3.4 of IEC 62109-2	Inverter backfeed current onto the array	Considered.	P
	The backfeed current testing and documentation requirements in Part 1 apply, including but not limited to the following.	Considered.	P
	Testing shall be performed to determine the current that can flow out of the inverter PV input terminals with a fault applied on inverter or on the PV input wiring. Faults to be considered include shorting all or part of the array, and any faults in the inverter that would allow energy from another source (for example the mains or a battery) to impress currents on the PV array wiring. The current measurement is not required to include any current transients that result from applying the short circuit, if such transients result from discharging storage elements other than batteries.	No backfeed current that can flow out of the inverter PV input terminals.	P
	This inverter backfeed current value shall be provided in the installation instructions regardless of the value of the current, in accordance with Table 33.		N/A

10	PROTECTION AGAINST SONIC PRESSURE HAZARDS		P
10.1	General		P
	The equipment shall provide protection against the effect of sonic pressure. Conformity tests are carried out if the equipment is likely to cause such HAZARDS.	No sonic pressure hazards.	P
10.2	Sonic pressure and Sound level		P
10.2.1	Hazardous Noise Levels		P



IEC/EN 62109-1, IEC/EN 62109-2			
Clause	Requirement – Test	Result – Remark	Verdict
11	PROTECTION AGAINST LIQUID HAZARDS		N/A
11.1	Liquid Containment, Pressure and Leakage	No liquid containment.	N/A
	The liquid containment system components shall be compatible with the liquid to be used.		N/A
	There shall be no leakage of liquid onto live parts as a result of:		N/A
	a) Normal operation, including condensation;		N/A
	b) Servicing of the equipment; or		N/A
	c) Inadvertent loosening or detachment of hoses or other cooling system parts over time.		N/A
11.2	Fluid pressure and leakage		N/A
11.2.1	Maximum pressure		N/A
11.2.2	Leakage from parts		N/A
11.2.3	Overpressure safety device		N/A
11.3	Oil and grease		N/A
12	CHEMICAL HAZARDS		N/A
12.1	General	No chemical hazards.	N/A
13	PHYSICAL REQUIREMENTS		P
13.1	Handles and manual controls		P
	Handles, knobs, grips, levers and the like shall be reliably fixed so that they will not work loose in normal use, if this might result in a hazard. Sealing compounds and the like, other than selfhardening resins, shall not be used to prevent loosening. If handles, knobs and the like are used to indicate the position of switches or similar components, it shall not be possible to fix them in a wrong position if this might result in hazard.	DC breaker holder for manual controls.	P
13.1.1	Adjustable controls	No such devices.	N/A
13.2	Securing of parts		P
13.3	Provisions for external connections		P
13.3.1	General		P
13.3.2	Connection to an a.c. Mains supply	AC connector to an a.c. mains supply.	P
13.3.2.1	General		P
	For safe and reliable connection to a MAINS supply, equipment shall be provided with one of the following:		P
	– terminals or leads or a non-detachable power supply cord for permanent connection to the supply; or	Screw terminal for permanent connection to the supply.	P
	– a non-detachable power supply cord for connection to the supply by means of a plug		N/A
	– an appliance inlet for connection of a detachable power supply cord; or		N/A
	– a mains plug that is part of direct plug-in equipment as in 13.3.8		N/A
13.3.2.2	Permanently connected equipment		P



IEC/EN 62109-1, IEC/EN 62109-2			
Clause	Requirement – Test	Result – Remark	Verdict
13.3.2.3	Appliance inlets		N/A
13.3.2.4	Power supply cord	No supply cord.	N/A
13.3.2.5	Cord anchorages and strain relief		N/A
	For equipment with a non-detachable power supply cord, a cord anchorage shall be supplied such that:		N/A
	– the connecting points of the cord conductors are relieved from strain; and	No supply cord.	N/A
	– the outer covering of the cord is protected from abrasion.	No supply cord.	N/A
13.3.2.6	Protection against mechanical damage		P
13.3.3	Wiring terminals for connection of external conductors	DC and AC terminals for connection of external conductors.	P
13.3.3.1	Wiring terminals		P
13.3.3.2	Screw terminals		P
13.3.3.3	Wiring terminal sizes		P
13.3.3.4	Wiring terminal design		P
13.3.3.5	Grouping of wiring terminals		P
13.3.3.6	Stranded wire		P
13.3.4	Supply wiring space		P
13.3.5	Wire bending space for wires 10 mm ² and greater		P
13.3.6	Disconnection from supply sources	Provided in installation manual.	P
13.3.7	Connectors, plugs and sockets		N/A
13.3.8	Direct plug-in equipment	Permanently equipment.	N/A
13.4	Internal wiring and connections		P
13.4.1	General		P
13.4.2	Routing		P
13.4.3	Colour coding	Green/yellow color wire as grounded wire.	P
13.4.4	Splices and connections		P
13.4.5	Interconnections between parts of the PCE		P
13.5	Openings in enclosures		N/A
13.5.1	Top and side openings	No opening in enclosure.	N/A
	Openings in the top and sides of ENCLOSURES shall be so located or constructed that it is unlikely that objects will enter the openings and create hazards by contacting bare conductive parts.		N/A
13.6	Polymeric Materials		N/A
13.6.1	General		P
13.6.1.1	Thermal index or capability	Considered.	P
13.6.2	Polymers serving as enclosures or barriers preventing access to hazards	Considered.	P
13.6.2.1	Stress relief test	Considered.	P
13.6.3	Polymers serving as solid insulation	Considered.	P
13.6.3.1	Resistance to arcing	Considered.	P
13.6.4	UV resistance	LCD screen with UV resistance cover.	P
	Polymeric parts of an OUTDOOR ENCLOSURE required for compliance with this standard shall be sufficiently resistance to degradation by ultra-violet (UV) radiation		P



IEC/EN 62109-1, IEC/EN 62109-2			
Clause	Requirement – Test	Result – Remark	Verdict
13.7	Mechanical resistance to deflection, impact, or drop		P
13.7.1	General		P
13.7.2	250-N deflection test for metal enclosures	No hazards.	P
13.7.3	7-J impact test for polymeric enclosures	No hazards.	P
13.7.4	Drop test		N/A
13.8	Thickness requirements for metal enclosures		N/A
13.8.1	General	No such materials	N/A
13.8.2	Cast metal		N/A
13.8.3	Sheet metal		N/A
13.9 of IEC 62109-2	Fault indication	LCD screen or interface connected to PC as fault indication.	P
	Where this Part 2 requires the inverter to indicate a fault, both of the following shall be provided:		P
	a) a visible or audible indication, integral to the inverter, and detectable from outside the inverter, and	LCD screen shown fault information.	P
	b) an electrical or electronic indication that can be remotely accessed and used.	The error message also can be remotely accessed and used	P
	The installation instructions shall include information regarding how to properly make connections (where applicable) and use the electrical or electronic means in b) above, in accordance with 5.3.2.10.	Provided in installation instruction.	P

14	COMPONENTS		P
14.1	General		P
	Where safety is involved, components shall be used in accordance with their specified RATINGS unless a specific exception is made. They shall conform to one of the following:	Considered.	P
	a) applicable safety requirements of a relevant IEC standard. Conformity with other requirements of the component standard is not required. If necessary for the application, components shall be subjected to the test of this standard, except that it is not necessary to carry out identical or equivalent tests already performed to check conformity with the component standard;	Considered.	P
	b) the requirements of this standard and, where necessary for the application, any additional applicable safety requirements of the relevant IEC component standard;	Considered.	P
	c) if there is no relevant IEC standard, the requirements of this standard;	Considered.	P
	d) applicable safety requirements of a non-IEC standard which are at least as high as those of the applicable IEC standard, provided that the component has been approved to the non-IEC standard by a recognized testing authority.	Considered.	P



IEC/EN 62109-1, IEC/EN 62109-2			
Clause	Requirement – Test	Result – Remark	Verdict
	Components such as optocouplers, capacitors, transformers, and relays connected across basic, supplemental, reinforced, or double insulation shall comply with the requirements applicable for the grade of insulation being bridged, and if not previously certified to the applicable component safety standard shall be subjected to the voltage test of 7.5.2 as routine test.	Considered.	P
14.2	Motor Overtemperature Protection		N/A
	Motors which, when stopped or prevented from starting (see 4.4.4.3), would present an electric shock HAZARD, a temperatur HAZARD, or a fire HAZARD, shall be protected by an overtemperature or thermal protection device meeting the requirements of 14.3.	No such devices.	N/A
14.3	Overtemperature protection devices	No such devices.	N/A
14.4	Fuse holders		N/A
14.5	MAINS voltage selecting devices	No such devices.	N/A
14.6	Printed circuit boards		P
	Printed circuit boards shall be made of material with a flammability classification of V-1 of IEC 60707 or better.	V-0 PCBs used.	P
	This requirements does not apply to thin-film flexible printed circuit boards that contain only circuits powered from limited power sources meeting the requirements of 9.2.		P
	Conformity of the flammability RATING is checked by inspection of data on the materials. Alternatively, conformity is checked by performing the V-1 tests specified in IEC 60707 on three samples of the relevant parts.		P
14.7	Circuits or components used as transient overvoltage limiting devices		P
	If control of transient overvoltage is employed in the equipment, any overvoltage limiting component or circuit shall be tested with the applicable impulse withstand voltage of Table 7-10 using the test method from 7.5.1 except 10 positive and 10 negative impulses are to be applied and may be spaced up to 1 min apart.	Considered.	P
14.8	Batteries		N/A
	Equipment containing batteries shall be designed to reduce the risk of fire, explosion and chemical leaks under normal conditions and after a single fault in the equipment including a fault in circuitry within the equipment battery pack.	No such devices.	N/A
14.8.1	Battery Enclosure Ventilation		N/A
14.8.1.1	Ventilation requirements		N/A
14.8.1.2	Ventilation testing		N/A
14.8.1.3	Ventilation instructions		N/A
14.8.2	Battery Mounting		N/A



IEC/EN 62109-1, IEC/EN 62109-2			
Clause	Requirement – Test	Result – Remark	Verdict
	Compliance is verified by the application of the force to the battery's mounting surface. The test force is to be increased gradually so as to reach the required value in 5 to 10 s, and is to be maintained at that value for 1 min. A nonmetallic rack or tray shall be tested at the highest normal condition operating temperature.		N/A
14.8.3	Electrolyte spillage		N/A
	Battery trays and cabinets shall have an electrolyte-resistant coating.		N/A
	The ENCLOSURE or compartment housing a VENTED BATTERY shall be constructed so that spillage or leakage of the electrolyte from one battery will be contained within the ENCLOSURE and be prevented from:		N/A
	a) reaching the PCE outer surfaces that can be contacted by the USER		N/A
	b) contaminating adjacent electrical components or materials; and		N/A
	c) bridging required electrical distances		N/A
14.8.4	Battery Connections		N/A
	Reverse battery connection of the terminals shall be prevented if reverse connection could result in a hazard within the meaning of this Standard		N/A
14.8.5	Battery maintenance instructions		N/A
	The information and instructions listed in 5.3.4.1 shall be included in the operator manual for equipment in which battery maintenance is performed by the operator, or in the service manual if battery maintenance is to be performed by service personnel only.		N/A
14.8.6	Battery accessibility and maintainability		N/A
	Battery terminals and connectors shall be accessible for maintenance with the correct TOOLS. Batteries with liquid electrolyte, requiring maintained shall be so located that the battery cell caps are accessible for electrolyte tests and readjusting of electrolyte levels.		N/A
15	Software and firmware performing safety functions	The software evaluated according to IEC 60730 annex H. See separated software evaluation report for detail.	P
Annex B	Programmable equipment		P
B.1	Software or firmware that performs safety critical functions	The software evaluated according to IEC 60730 annex H. See separated software evaluation report for detail.	P



IEC/EN 62109-1, IEC/EN 62109-2			
Clause	Requirement – Test	Result – Remark	Verdict
B.1.1	Firmware or software that performs a critical safety function/s, such as protection from excessive temperature, over current or improper synchronization of AC sources, the failure of which can result in a risk of fire, electric shock or other hazard as specified by this standard, shall be evaluated by one of the following means.	The software evaluated according to IEC 60730 annex H. See separated software evaluation report for detail.	P
	a) All software or firmware limits or controls shall be disabled before the test to evaluate the hardware circuitry during the abnormal test condition related to the safety function, or the hardware sensor component that is monitored by the firmware or software is modified or disabled to prevent the software or firmware from reading or responding to the abnormal condition.		N/A
	b) Protective controls employing software or firmware to perform their function(s) shall be so constructed that they comply with IEC 60730-1 Annex H to address the risks identified in B.2.1. Each combination of microprocessor model, manufacturer and firmware/software version used in the production of a PCE shall be evaluated as specified in the remainder of Annex B.	The software evaluated according to IEC 60730 annex H. See separated software evaluation report for detail.	P
	Exception: For units with firmware/software that has been found to be compliant with the remainder of Annex B, subsequent firmware/software revisions may be entitled to a limited reevaluation for the revised firmware or software. The scope of the reevaluation shall be defined by the potential impact of the firmware or software revisions and the applicable portions of IEC 60730-1 Annex H shall be reapplied.		P
B.2	Evaluation of controls employing software	The software evaluated according to IEC 60730 annex H. See separated software evaluation report for detail.	P
B.2.1.1	A risk analysis shall be conducted to determine a set of risks and that the software addresses the identified risks. The risk analysis shall be conducted based on the safety requirements for the programmable component.		P
B.2.1.2	An analysis shall be conducted to identify the critical, non-critical, and supervisory parts of the software.		P
B.2.1.3	An analysis shall be conducted to identify transitions or states that can result in a risk.		P
B.2.1.4	Risks to be considered include, but are not limited to functions associated with the following:		P
	a) Temperature control, monitoring and response (i.e. coolant, internal ambient, device)		P
	b) Safety interlocks		P
	c) Synchronization between multiple AC sources		P
	d) Emergency stop of operation (including staged shutdown / sequencing)		P



IEC/EN 62109-1, IEC/EN 62109-2			
Clause	Requirement – Test	Result – Remark	Verdict
	e) Connection / disconnection – from an input source and output source		P
	f) RCD functions		P
	g) Over current protection or control		P

Annex J	Ultraviolet light conditioning test		N/A
J.1	General	Certificated plastic enclouse used.	N/A
	Samples mounted as in Clause J.2 are to be exposed to ultraviolet light by using either the apparatus in Clauses J.3 or J.4, and shall comply with the criteria in 13.6.4.		N/A
J.2	Mounting of test samples	Certificated plastic enclouse used.	N/A
	The samples are mounted vertically on the inside of the cylinder of the light exposure apparatus, with the widest portion of the sample facing the arcs. They are mounted so that they do not touch each other.		N/A
J.3	Carbon-arc light-exposure apparatus	Certificated plastic enclouse used.	N/A
	The apparatus described in ISO 4892-4, or equivalent, is used in accordance with the procedures given in ISO 4892-1 and ISO 4892-4 using a type 1 filter, with water spray.		N/A
J.4	Xenon-arc light-exposure apparatus	Certificated plastic enclouse used.	N/A
	The apparatus described in ISO 4892-2, or equivalent, is used in accordance with the procedures given in ISO 4892-1 and ISO 4892-2 using method A, with water spray.		N/A



4.2.2.6 TABLE: mains supply electrical data in normal condition						P
Type	U (V) DC	I (A) DC	P (W) DC	U (V) grid	I (A) AC	P (W) AC
SOFAR 1100TL	90	2.10	196	230V/50Hz	0.77	173
SOFAR 1100TL	110	9.95	1095	230V/50Hz	4.45	1024
SOFAR 1100TL	380	2.74	1040	230V/50Hz	4.37	1005
SOFAR 1100TL	400	2.03	810	230V/50Hz	3.36	773
SOFAR 1100TL	450	0	0	230V/50Hz	0	0
SOFAR 1100TL	90	5.02	461	230V/60Hz	1.88	430
SOFAR 1100TL	110	9.91	1099	230V/60Hz	4.55	1048
SOFAR 1100TL	380	2.91	1097	230V/60Hz	4.60	1060
SOFAR 1100TL	400	1.94	779	230V/60Hz	3.28	756
SOFAR 1100TL	450	0	0	230V/60Hz	0	0
SOFAR 1600TL	90	2.84	254	230V/50Hz	1.01	230
SOFAR 1600TL	165	9.66	1595	230V/50Hz	6.57	1515
SOFAR 1600TL	380	4.06	1546	230V/50Hz	6.53	1501
SOFAR 1600TL	400	2.73	1097	230V/50Hz	4.63	1064
SOFAR 1600TL	450	0	0	230V/50Hz	0	0
SOFAR 1600TL	90	2.84	255	230V/60Hz	1.01	230
SOFAR 1600TL	165	9.66	1595	230V/60Hz	6.59	1515
SOFAR 1600TL	380	4.06	1546	230V/60Hz	6.53	1501
SOFAR 1600TL	400	2.73	1097	230V/60Hz	4.63	1064
SOFAR 1600TL	450	0	0	230V/60Hz	0	0
SOFAR 2200TL	100	8.2	821	230V/50Hz	3.43	787
SOFAR 2200TL	170	12.5	2142	230V/50Hz	8.85	2037
SOFAR 2200TL	450	4.75	2141	230V/50Hz	9.04	2074
SOFAR 2200TL	480	2.47	1181	230V/50Hz	4.90	1130
SOFAR 2200TL	500	0	0	230V/50Hz	0	0
SOFAR 2200TL	100	8.28	821	230V/60Hz	3.30	766
SOFAR 2200TL	170	12.23	2098	230V/60Hz	8.70	2002
SOFAR 2200TL	450	4.67	2098	230V/60Hz	8.82	2025
SOFAR 2200TL	480	2.35	1128	230V/60Hz	5.17	1089
SOFAR 2200TL	500	0	0	230V/60Hz	0	0



**BUREAU
VERITAS**

Test Report No: LD140508N005-R2

Type	U (V) DC	I (A) DC	P (W) DC	U (V) grid	I (A) AC	P (W) AC
SOFAR 2700TL	100	6.80	684	230V/50Hz	2.76	634
SOFAR 2700TL	210	12.53	2633	230V/50Hz	10.90	2505
SOFAR 2700TL	450	5.83	2623	230V/50Hz	11.04	2535
SOFAR 2700TL	480	2.97	1431	230V/50Hz	6.00	1378
SOFAR 2700TL	500	0	0	230V/50Hz	0	0
SOFAR 2700TL	100	6.62	661	230V/60Hz	2.68	617
SOFAR 2700TL	210	12.46	2629	230V/60Hz	10.87	2507
SOFAR 2700TL	450	5.17	2629	230V/60Hz	10.94	2520
SOFAR 2700TL	480	2.90	1389	230V/60Hz	5.86	1351
SOFAR 2700TL	500	0	0	230V/60Hz	0	0
SOFAR 3000TL	100	5.71	570	230V/50Hz	2.29	526
SOFAR 3000TL	230	12.78	2942	230V/50Hz	12.20	2803
SOFAR 3000TL	450	6.54	2944	230V/50Hz	12.36	2842
SOFAR 3000TL	480	4.66	2234	230V/50Hz	9.43	2166
SOFAR 3000TL	500	0	0	230V/50Hz	0	0
SOFAR 3000TL	100	5.09	510	230V/60Hz	2.07	472
SOFAR 3000TL	230	12.75	2946	230V/60Hz	12.25	2810
SOFAR 3000TL	450	6.55	2944	230V/60Hz	12.40	2845
SOFAR 3000TL	480	3.51	1690	230V/60Hz	7.12	1640
SOFAR 3000TL	500	0	0	230V/60Hz	0	0



4.3	TABLE: heating temperature rise measurements (SOFAR 1100TL)				P	
	Test voltage (V)	A: 110Vdc/9.95A; 230Vac/50Hz B: 110Vdc/7.04A; 230Vac/50Hz C: 380Vdc/2.74A; 230Vac/50Hz D: 380Vdc/2.26A; 230Vac/50Hz			—	
	t1 (°C)	See below			—	
	t2 (°C)	See below			—	
Temperature T of part/at:		Measured T (°C)				Limit T (°C)
		A	B	C	D	
Ambient		45.0	62.7	45.0	60.4	--
DC connector		50.6	66.4	48.1	62.9	85
Input wire		56.1	69.6	49.9	64.6	105
Relay RYP3		55.9	69.8	50.4	64.5	85
Choke LP2		60.5	72.2	51.9	64.8	130
Relay RYP1		60.3	72.5	52.3	66.5	85
Y-Cap CP63		64.0	74.5	52.9	67.0	85
Capacitor CP61		61.4	72.7	53.5	67.7	85
BUS capacitor ECP3		66.3	76.2	55.3	66.7	105
PCB near DP1		68.9	79.7	56.3	69.1	130
PCB near QP3		85.8	96.1	54.0	71.1	130
Y-cap CP1		67.3	78.2	55.5	68.4	85
X-cap CP100		66.6	78.0	56.9	70.1	100
Transformer TXP1 winding		69.5	81.1	61.5	71.3	110
Transformer TXP1 core		70.5	81.8	62.5	75.4	110
Y-cap CP96		67.4	79.6	59.7	76.3	85
Opto-coupler UP14		68.8	80.8	60.8	74.0	100
PCB near DP15		71.5	83.2	64.4	75.1	130
TP1 winding		68.2	80.3	61.2	78.2	130
TP1 core		67.8	79.9	61.0	75.4	130
Boost choke lead wire		71.5	80.1	53.8	75.2	105
PCB near QP1		66.1	77.5	57.3	68.5	130
Boost choke		95.2	99.5	54.8	72.1	130
Inverter Choke lead wire		63.6	75.2	56.1	69.9	105
Inverter Choke 1 winding		76.7	84.5	68.8	70.6	130
Inverter Choke 2 winding		72.2	81.7	65.7	83.3	130
X-cap CP80		64.1	76.1	57.9	80.6	100
X-cap CP79		62.7	75.1	56.9	72.3	100
Current transducer HLP2		65.4	77.5	59.3	71.2	85
Relay RYP2 ambient		64.6	77.1	58.2	73.6	85
Relay RYP2 enclosure		65.6	78.1	59.7	72.7	85
Relay RYP5 ambient		63.2	75.8	56.1	74.0	85
Relay RYP5 enclosure		65.5	78.0	59.6	70.8	85
Choke LP3		61.1	74.2	55.2	73.9	130
PCB near QP2		64.6	76.5	57.0	70.0	130
Y-cap CP75		59.7	73.1	53.9	71.8	85
Choke LP4		57.7	71.6	52.8	68.8	130
X-cap CP81		56.0	70.4	51.6	67.7	100
GFCI LP5 winding		55.6	70.3	51.6	66.4	130
Varistor RVP5		54.4	69.7	50.8	66.4	85
PCB near main DSP		68.9	83.2	64.7	65.9	130



**BUREAU
VERITAS**

Test Report No: LD140508N005-R2

PCB near slave DSP	69.6	83.7	64.8	79.3	130
opto-coupler UC6	60.3	75.3	56.8	79.4	100
PCB near UT1	65.3	79.8	61.2	71.7	130
Ouput wire	53.3	68.5	49.9	76.0	105
AC connector	51.1	66.8	48.3	65.0	90
Display button	45.4	62.7	45.4	63.4	70
DC Switch knob	47.0	64.0	46.3	61.3	70
Heat sink top	61.9	73.9	53.0	67.8	100*
Accessible enclosure surface(side)	62.2	74.5	52.2	67.2	100*
Heat sink back	64.4	75.8	53.3	68.3	100*

supplementary information

* The symbol  is marked on the heating sink.



4.3	TABLE: heating temperature rise measurements (SOFAR 3000TL)				P
	Test voltage (V)	A: 230Vdc/12.78A; 230Vac/50Hz B: 230Vdc/8.31A; 230Vac/50Hz C: 450Vdc/6.54A; 230Vac/50Hz D: 450Vdc/3.95A; 230Vac/50Hz			—
	t1 (°C).....	See below			—
	t2 (°C)	See below			—
Temperature T of part/at:	Measured T (°C)				Limit T (°C)
	A	B	C	D	
Ambient	45.1	61.7	45.0	64.5	--
DC connector	54.4	65.7	51.9	68.2	85
Input wire	68.2	71.1	59.9	70.2	105
Relay RYP3	67.6	74.3	60.4	71.0	85
Choke LP2	73.7	75.1	63.5	71.6	130
Relay RYP1	66.1	63.8	62.2	73.2	85
Y-Cap CP63	72.0	74.6	64.4	66.4	85
Capacitor CP61	68.6	72.5	61.9	74.1	85
BUS capacitor ECP3	75.0	76.4	67.6	73.2	105
PCB near DP1	86.1	87.7	74.3	76.4	130
PCB near QP3	100.3	102.1	66.6	79.3	130
Y-cap CP1	74.9	78.8	67.4	75.3	85
X-cap CP100	72.7	77.8	67.5	76.9	100
Transformer TXP1 winding	78.2	82.7	74.4	78.0	110
Transofrmer TXP1 core	77.8	82.3	75.2	83.7	110
Y-cap CP96	76.6	81.1	72.2	79.5	85
Opto-coupler UP14	79.0	83.2	75.9	82.0	100
PCB near DP15	79.9	84.1	75.7	84.1	130
TP1 winding	76.7	81.0	72.8	84.9	130
TP1 core	76.4	80.9	72.5	82.4	130
Boost choke lead wire	79.6	80.1	66.1	82.5	105
PCB near QP1	83.7	86.0	79.0	75.4	130
Boost choke	87.9	85.3	67.5	82.6	130
Inverter Choke lead wire	84.8	83.9	82.6	75.7	105
Inverter Choke 1 winding	96.6	91.3	98.8	87.9	130
Inverter Choke 2 winding	93.0	89.5	96.2	99.1	130
X-cap CP80	74.1	78.0	70.6	98.2	100
X-cap CP79	73.6	77.8	71.0	79.3	100
Current transducer HLP2	77.5	80.3	74.3	79.4	85
Relay RYP2 ambient	72.3	76.7	72.2	81.7	85
Relay RYP2 enclosure	72.0	76.2	74.7	79.5	85
Relay RYP5 ambient	75.5	78.7	71.4	78.8	85
Relay RYP5 enclosure	76.1	76.3	72.6	80.2	85
Choke LP3	74.8	77.1	70.8	77.3	130
PCB near QP2	82.4	84.9	78.5	79.0	130
Y-cap CP75	71.0	75.4	67.0	82.7	85
Choke LP4	71.1	74.4	67.4	77.1	130
X-cap CP81	65.4	72.0	62.0	76.9	100
GFCI LP5 winding	65.5	72.2	62.1	74.5	130
Varistor RVP5	63.8	71.2	60.2	74.8	85
PCB near main DSP	72.8	81.8	69.3	74.2	130



**BUREAU
VERITAS**

Test Report No: LD140508N005-R2

PCB near slave DSP	75.3	84.6	72.3	78.7	130
opto-coupler UC6	69.9	79.1	66.8	86.5	100
PCB near UT1	69.7	79.5	66.9	81.3	130
Output wire	66.3	71.8	62.9	81.3	105
AC connector	56.0	66.6	53.4	74.6	90
Display button	49.0	63.7	48.5	66.2	70
DC Switch knob	48.9	63.3	48.3	66.1	70
Heat sink top	69.0	75.3	63.6	74.6	100*
Accessible enclosure surface(side)	64.2	72.6	60.2	72.3	100*
Heat sink back	68.9	75.9	64.9	74.9	100*

supplementary information

* The symbol  is marked on the heating sink.



4.4		TABLE: fault condition tests							P
		ambient temperature (°C) :						25	—
No.	component No.	fault	test voltage (Vdc)		test time	fuse No.	fuse current (A)		result
			AC	DC			AC	DC	
1.	ECP1	Short	230V 12.68A	450V 6.8A	2 Min.	--	230V 0A	1.45V 8A	PV inverter disconnected from grid immediately, AC breaker open, QP2, QP6 damaged, no hazard.
2.	QP2 Pin G-C	Short	230V 12.63A	450V 6.55A	2 Min.	--	230V 0A	450V 0.02A	PV inverter disconnected from grid immediately, UP2, UP3, QP1, QP2, QP6, QP7, QP5, RP11, RP12, RP15, RP32, RP28, RP26 damaged, no hazard.
3.	QP2 Pin G-E	Short	230V 12.67A	450V 6.8A	2 Min.	--	230V 0.17 A	450V 0.02A	PV inverter disconnected from grid immediately, no damaged, no hazard.
4.	QP2 Pin C-E	Short	230V 12.78A	450V 6.8A	2 Min.	--	230V 0A	1.9V 13.0A	PV inverter disconnected from grid immediately, QP1, QP2, QP6, QP7 damaged, no hazard.
5.	QP6 Pin G-C	Short	230V 12.78A	450V 6.8A	2 Min.	--	230V 0A	450V 0.02A	PV inverter disconnected from grid immediately, UP2, UP3, QP6, QP7, QP1, QP2, RP32, PR28, PR26, QP9, RP11, RP12, RP15, QP5 damaged, no hazard.
6.	QP6 Pin G-E	Short	230V 12.74A	450V 6.75A	2 Min.	--	230V 0A	450V 0.02A	PV inverter disconnected from grid immediately, no damaged, no hazard.
7.	QP6 Pin C-E	Short	230V 12.74A	450V 6.75A	2 Min.	--	230V 0A	1.9V 13.1A	PV inverter disconnected from grid immediately, QP1, QP2, QP6, QP7 damaged, no hazard.
8.	UP12 VCC to GND	Short	230V 12.73A	450V 6.8A	2 Min.	--	230V 0.17 A	450V 0.01A	PV inverter disconnected from grid immediately, no damaged, no hazard.
9.	TXP1 Pin1-4	Short	230V 12.73A	450V 6.8A	2 Min.	--	230V 0.17 A	450V 0.01A	PV inverter disconnected from grid immediately, no damaged, no hazard.
10.	TXP1 Pin1-4	Short	230V 12.72A	450V 6.81A	2 Min.	--	230V 0.17 A	450V 0.01A	PV inverter disconnected from grid immediately, no damaged, no hazard.
11.	TXP1 Pin6-7	Short	230V 12.72A	450V 6.81A	2 Min.	--	230V 12.7 5A	450V 6.85A	PV inverter normal working, no damaged, no hazard.



12.	TXP1 Pin13-14	Short	230V 12.72A	450V 6.81A	2 Min.	--	230V 12.7 2A	450V 6.85A	PV inverter normal working, no damaged, no hazard.
13.	TXP1 Pin8-9	Short	230V 12.73A	450V 6.81A	2 Min.	--	230V 12.7 3A	450V 6.85A	PV inverter normal working, no damaged, no hazard.
14.	TXP1 Pin9-10	Short	230V 12.70A	450V 6.8A	2 Min.	--	230V 0.17 A	450V 0.01A	PV inverter disconnected from grid immediately, no damaged, no hazard.
15.	TXP1 Pin10-11	Short	230V 12.74A	450V 6.85A	2 Min.	--	230V 12.7 4A	450V 6.85A	PV inverter normal working, no damaged, no hazard.
16.	PV + to -	Reversed	230V 0.16A	450V 0.02A	2 Min.	--	230V 0.16 A	450V 0.02A	PV inverter can not start up.
17.	PV + to -	Short	230V 0.16A	450V 0.02A	2 Min.	--	230V 0.16 A	450V 0.02A	PV inverter can not start up.
18.	L to N	Reversed	230V 12.74A	450V 6.85A	2 Min.	--	230V 12.7 4A	450V 6.85A	PV inverter normal working, no damaged, no hazard.
19.	Ventilation	Blanket wrapped	230V 9.4A	230V 12.19 A	2.4 hours	--	230V 3.74 A	270V 4.3A	PV inverter output power decrease from 2.8kW to 0.86kW, no damaged, no hazard.
20.	PV voltage detect UC1C Pin 9	Open	230V 12.63A	450V 6.62A	2 Min.	--	230V 0.17 A	450V 0.02A	PV inverter disconnected from grid immediately, error message: ID09. (PV voltage over range)
21.	PV current detect UC1B Pin 5	Open	230V 12.63A	450V 6.6A	2 Min.	--	230V 0.16 A	450V 0.02A	PV inverter disconnected from grid immediately, error message: ID14. (PV current over range)
22.	GFCI detect UC2D Pin 12-13	Short	230V 12.63A	450V 6.62A	2 Min.	--	230V 0.16 A	450V 0.02A	PV inverter disconnected from grid immediately, error message: ID12. (GFCI fault)
23.	GFCI detect UC2C Pin 10	Short	230V 12.63A	450V 6.62A	2 Min.	--	230V 0.16 A	450V 0.02A	PV inverter disconnected from grid immediately, error message: ID52. (GFCI fault)
24.	Grid voltage detect UC2A Pin 3	Open	230V 12.64A	450V 6.67A	2 Min.	--	230V 0.17 A	450V 0.02A	PV inverter disconnected from grid immediately, error message: ID15. (Grid current or voltage over range)



25.	Grid voltage detect RC17	Open	230V 12.63A	450V 6.62A	2 Min.	--	230V 0.17 A	450V 0.01A	PV inverter disconnected from grid immediately, error message: ID02, ID49, ID70. (Grid current or voltage under range)
26.	Grid voltage detect RC25	Open	230V 12.64A	450V 6.62A	2 Min.	--	230V 0.18 A	450V 0.01A	PV inverter disconnected from grid immediately, error message: ID55. (Relay fault)
27.	Bus voltage detect RP3	Open	230V 12.61A	450V 6.63A	2 Min.	--	230V 0.6A	450V 0.02A	PV inverter disconnected from grid immediately, error message: ID23. (Bus voltage zero fault)
28.	Bus voltage detect UC1A Pin2-3	Short	230V 12.56A	450V 6.65A	2 Min.	--	230V 0.17 A	450V 0.02A	PV inverter disconnected from grid immediately, error message: ID66. (Bus voltage over range)
29.	Bus voltage detect RC82	Short	230V 12.56A	450V 6.69A	2 Min.	--	230V 0.16 A	450V 0.02A	PV inverter disconnected from grid immediately, error message: ID25. (Bus voltage under range)
30.	ISO detect RC105	Open before start	230V 0.17A	450V 0.18A	2 Min.	--	230V 0.17 A	450V 0.02A	PV inverter can not start up, error message: ID56. (ISO fault)
31.	AC current detect RC22	Open	230V 12.56	450V 6.68	2 Min.	--	230V 0.17 A	450V 0.02A	PV inverter disconnected from grid immediately, error message: ID15. (AC current over range), QP2, QP6, QP9, RP26, RP28, RP11 damaged.
32.	AC current detect RC21	Open	230V 12.62A	450V 6.63A	2 Min.	--	230V 0.16 A	450V 0.02A	PV inverter disconnected from grid immediately, error message: ID15. (AC current over range).
33.	DC current detect RC33	Open	230V 12.67A	450V 6.69A	2 Min.	--	230V 0.17 A	450V 0.02A	PV inverter disconnected from grid immediately, error message: ID28. (DC current over range).
34.	DC current detect RC37	Open	230V 12.54A	450V 6.67A	2 Min.	--	230V 0.17 A	450V 0.02A	PV inverter disconnected from grid immediately, error message: ID28. (DC current over range).
35.	DC current detect RC42	Open	230V 12.62A	450V 6.66A	2 Min.	--	230V 0.16 A	450V 0.02A	PV inverter disconnected from grid immediately, error message: ID51. (DC current fault).



36.	AC current detect RC61	Open	230V 12.66A	450V 6.7A	2 Min.	--	230V 0.16 A	450V 0.02A	PV inverter disconnected from grid immediately, error message: ID15, ID65. (AC voltage or current over range).
37.	AC current detect RC80	Open	230V 12.67A	450V 6.8A	2 Min.	--	230V 0.16 A	450V 0.02A	PV inverter disconnected from grid immediately, error message: ID15, ID65. (AC voltage or current over range).
38.	GFCI detect RP70	Open	230V 12.63A	450V 6.66A	2 Min.	--	230V 0.16 A	450V 0.02A	PV inverter disconnected from grid immediately, error message: ID12. (GFCI fault).
39.	GFCI detect RP80	Open	230V 12.63A	450V 6.66	2 Min.	--	230V 0.16 A	450V 0.02A	PV inverter disconnected from grid immediately, error message: ID12. (GFCI fault).
40.	GFCI detect UP7A Pin2-3	Short	230V 12.56A	450V 6.67A	2 Min.	--	230V 0.17 A	450V 0.02A	PV inverter disconnected from grid immediately, error message: ID12. (GFCI fault).
41.	PV voltage detect RP115	Open	230V 12.62A	450V 6.67A	2 Min.	--	230V 0.16 A	450V 0.02A	PV inverter disconnected from grid immediately, no display, and reconnect to grid, error message: ID56. (ISO fault).
42.	PV voltage detect RP115	Short	230V 12.63A	450V 6.63A	2 Min.	--	230V 0.16 A	450V 0.02A	PV inverter disconnected from grid immediately, error message: ID09. (PV voltage over range)
43.	ISO detect RP99	Open before start	230V 0.16A	450V 0.02A	2 Min.	--	230V 0.16 A	450V 0.02A	PV inverter can not start up, error message: ID56. (ISO fault).
44.	Relay detect RYP2 Pin3-4	Short before start	230V 0.16A	450V 0.02A	2 Min.	--	230V 0.16A	450V 0.02A	PV inverter can not start up, error message: ID55, ID77. (Relay fault).
45.	Relay detect RYP3 Pin3-4	Short before start	230V 0.16A	450V 0.02A	2 Min.	--	230V 0.16 A	450V 0.02A	PV inverter can not start up, error message: ID55, ID77. (Relay fault).
46.	Relay detect RYP4 Pin3-4	Short before start	230V 0.16A	450V 0.02A	2 Min.	--	230V 0.16 A	450V 0.02A	PV inverter can not start up, error message: ID55, ID77. (Relay fault).
47.	Relay detect RYP5 Pin3-4	Short before start	230V 0.16A	450V 0.02A	2 Min.	--	230V 0.16 A	450V 0.02A	PV inverter can not start up, error message: ID55, ID77. (Relay fault).



48.	Grid voltage detect RP150	Open	230V 0.62A	450V 6.67A	2 Min.	--	230V 0.16 A	450V 0.02A	PV inverter disconnected from grid immediately, error message: ID02. (Grid voltage under range)
49.	Grid voltage detect RP150	Short	230V 12.64A	450V 6.66A	2 Min.	--	230V 0.16 A	450V 0.02A	PV inverter disconnected from grid immediately, error message: ID01. (Grid voltage over range)
50.	Grid voltage detect RP135	Short	230V 12.64A	450V 6.67A	2 Min.	--	230V 0.16 A	450V 0.02A	PV inverter disconnected from grid immediately, error message: ID01. (Grid voltage over range)
51.	Grid voltage detect RP135	Open	230V 12.61A	450V 6.66A	2 Min.	--	230V 0.16 A	450V 0.02A	PV inverter disconnected from grid immediately, error message: ID02. (Grid voltage under range)
52.	Loss of control CC100	Short	230V 12.61A	450V 6.67A	2 Min.	--	230V 0.16 A	450V 0.02A	PV inverter disconnected from grid immediately, error message: DSP communicate fail
53.	Loss of control XLC	Short	230V 12.63A	450V 6.65A	2 Min.	--	230V 0.16 A	450V 0.02A	PV inverter disconnected from grid immediately, error message: DSP communicate fail
54.	Communication microcontroller defect UC34 Pin 31	Open	230V 12.64A	450V 6.66A	2 Min.	--	230V 0.16 A	450V 0.02A	PV inverter disconnected from grid immediately, error message: ID 53 (SPI Communication fault)
55.	Communication microcontroller defect UC34 Pin 37	Open	230V 12.64A	450V 6.66A	2 Min.	--	230V 0.17 A	450V 0.02A	PV inverter disconnected from grid immediately, error message: ID 53 (SPI Communication fault)
56.	Communication microcontroller defect UC34 Pin 44	Open	230V 12.63A	450V 6.66A	2 Min.	--	230V 0.17 A	450V 0.02A	PV inverter disconnected from grid immediately, error message: ID 53 (SPI Communication fault)
57.	Communication microcontroller defect UC34 Pin 47	Open	230V 12.64A	450V 6.67A	2 Min.	--	230V 0.17 A	450V 0.02A	PV inverter disconnected from grid immediately, error message: ID 53 (SPI Communication fault)

Supplementary information: s-c stands for short-circuit; o-l stands for overload.

See technical documentation.



7.3.7	TABLE: clearance and creepage distance measurements					P
clearance cl and creepage distance dcr at / of:	Up (V)	U r.m.s. (V)	required cl (mm)	cl (mm)	required dcr (mm)	dcr (mm)
TXP1 core to capacitor (BI) (Main board)	52	--	3.0	4.6	3.0	4.6
TXP1 core to primary (BI) (Main board)	52	--	3.0	4.1	3.0	4.1
TXP1 core to secondary (SI) (Main board)	52	--	3.0	4.3	3.0	4.3
TXP1 primary to secondary (RI) (Main board)	52	--	5.5	6.3	5.5	6.3
TXP1 primary to secondary on PCB board (RI) (Main board)	52	--	5.5	6.3	5.5	6.3
Primary circuits to secondary circuits on PCB board (RI) (Main board)	--	230	5.5	6.1	5.6	6.1
Relay (RYP2, RYP3, RYP4, RYP5) two polarity on PCB board (BI) (Main board)	--	230	3.0	6.0	3.0	6.0
Y capacitor (CP83) to earthing on PCB board (BI) (Main board)	--	230	3.0	5.1	3.0	5.1
Y capacitor (CP85) to earthing on PCB board (BI) (Main board)	--	230	3.0	4.5	3.0	4.5
BUS- (PP12) to earthing on PCB board (BI) (Main board)	--	230	3.0	5.1	3.0	5.1
Y capacitor (CP13) to earthing on PCB board (BI) (Main board)	--	230	3.0	4.8	3.0	4.8
Y capacitor (CP63) to earthing on PCB board (BI) (Main board)	--	230	3.0	5.4	3.0	5.4
Y capacitor (CP64) to earthing on PCB board (BI) (Main board)	--	230	3.0	5.1	3.0	5.1
Capacitor (CC90) to earthing on PCB board (BI) (Main board)	--	230	3.0	5.7	3.0	5.7
MOSFET (QP1, QP2, QP3, QP6, QP7, DP1) to earthing (BI) (Main board)	550	230	3.0	5.9	5.5	5.9
Primary circuits to secondary circuits on PCB board (RI) (Communication board)	--	230	5.5	6.5	5.6	6.5
Supplementary information: RI: Reinforced insulation, DI: double insulation, BI: basic insulation, SI: supplementary insulation The double side PCB layout is considered and evaluated.						



7.3.7.8.3.2 TABLE: distance through insulation measurement				P
to				
7.3.7.8.3.3				
distance through insulation distance at/of:	U r.m.s. (V)	test voltage (Vdc)	required di (mm)	di (mm)
Insulation sheet	550	4665	--	2.0
Photo coupler (certified)*	550	5090	0.2	0.40
* Approved components.				

7.5 TABLE: electric strength measurements, impulse voltage test and partial discharge test				P
test voltage applied between:	test voltage (V)	impulse withstand voltage (V)	partial discharge extinction voltage (V)	result
DC input terminal to earthed enclosure	2545	4000	—	Pass
DC input terminal to communication port	5090	6000	—	Pass
AC output terminal to earthed enclosure	2120	4000	—	Pass
AC output terminal to communication port	4240	6000	—	Pass
Insulation sheet	2545	4000	—	Pass
Transformer (TXP1) Pri. to Sec.	2545	4000	—	Pass
Transformer (TXP1) Pri. to core	2545	4000	—	Pass
Transformer (TXP1) Sec. to Core	5090	6000	—	Pass
Two layers of insulation tape	5090	6000	—	Pass
Relay pin 3 to pin 4	2545	4000	—	Pass



14	TABLE: list of critical components				P
object/part No.	manufacturer/ trademark	type/model	technical data	standard	mark(s) of conformity ¹⁾
Enclosure	All	All accepted	Metal, Thickness: 1.2mm min.	--	--
Heat-sink (the rear side of enclosure)	All	All accepted	Metal, overall measured: L: 310mm, W: 310mm, H: 32mm	--	--
Plastic cover (LCD screen)	BAYER MATERIALSCIE NCE AG	6557 + (z)(f1)	V-0, 3.0mm thickness, 115°C	UL 94 UL 746C	UL E41613
DC connector	Amphenol Industrial Operations	Helios H4 series	1000Vdc, 40A, Max. 90°C, IP68	DIN EN 50521	TUV, R 50157783
	Phoenix Contact GmbH & Co. KG	PV-FT-CF-C; PV-FT-CM-C	1000Vdc, 40A, Max.85°C, IP65	DIN EN 50521	TUV, R 60029159
Internal wiring (DC-in)	All	All accepted	Min. 12AWG, 600V, 105°C, VW-1	UL 758	UL
Internal wiring (AC-out)	All	All accepted	Min. 12AWG, 600V, 105°C, VW-1	UL 758	UL
Earthing wire	All	All accepted	Min. 12AWG, 600V, 105°C, VW-1	UL 758	UL
Boost inductor (For SOFAR 3000TL, SOFAR 2700TL, SOFAR 2200TL)	HUIZHOU BAOHUI ELECTRONICS TECHNOLOGY CO., LTD.	SH-L016	1.9mH, 130°C	--	--
	Bo Luo Da Xin Electronic Co.,Ltd				
Boost inductor (For SOFAR 1100TL, SOFAR 1600TL)	HUIZHOU BAOHUI ELECTRONICS TECHNOLOGY CO., LTD.	SH-L021	2.6mH, 130°C	--	--
	Bo Luo Da Xin Electronic Co.,Ltd				
- Lead Wiring	All	All accepted	12AWG, 600V, 105°C, VW-1	UL 758	UL
Inverter inductor (For SOFAR 3000TL)	HUIZHOU BAOHUI ELECTRONICS TECHNOLOGY CO., LTD.	SH-L015	1.3mH, 130°C	--	--
	Bo Luo Da Xin Electronic Co.,Ltd				



14 TABLE: list of critical components					P
object/part No.	manufacturer/ trademark	type/model	technical data	standard	mark(s) of conformity ¹⁾
Inverter inductor (For SOFAR 2700TL)	HUIZHOU BAOHUI ELECTRONICS TECHNOLOGY CO., LTD.	SH-L020	1.5mH, 130°C	--	--
	Bo Luo Da Xin Electronic Co.,Ltd				
Inverter inductor (For SOFAR 2200TL)	HUIZHOU BAOHUI ELECTRONICS TECHNOLOGY CO., LTD.	SH-L019	2.1mH, 130°C	--	--
	Bo Luo Da Xin Electronic Co.,Ltd				
Inverter inductor (For SOFAR 1600TL)	HUIZHOU BAOHUI ELECTRONICS TECHNOLOGY CO., LTD.	SH-L018	2.3mH, 130°C	--	--
	Bo Luo Da Xin Electronic Co.,Ltd				
Inverter inductor (For SOFAR 1100TL)	HUIZHOU BAOHUI ELECTRONICS TECHNOLOGY CO., LTD.	SH-L017	3.4mH, 130°C	--	--
	Bo Luo Da Xin Electronic Co.,Ltd				
- Lead Wiring	All	All accepted	12AWG, 600V, 105°C, VW-1	UL 758	UL
AC connector	Kunshan GRantech Electronics and technology Co., Ltd.	PVPM3251- 8GS02-BF	V-0, 250V, 20A, Max.: 100°C, IP68	DIN EN 61984	TUV SUD, B 13 01 82966 001
	Shanghai Vaconn Electronic Technology Co. Ltd	VPAC07EW-3S	V-0, 300V, 30A, Max.: 90°C, IP67	DIN EN 61984	TUV, R 50235418
DC Switch (Optional)	MERZ	MDC1A-025-600	600Vdc, 30A, Max.: 70°C, IP65	EN 60947	DEKRA, 2141205.01
	SANTON	XA100.16	1000Vdc, 16A, or 800Vdc, 25A, Max.: 70°C, IP66	EN 60947	DEKRA, 2152871.01
	Santon International B.V.	XBE+3210/2	1000Vdc 16Adc, Max. 85°C	EN 60947- 3:2009, EN60947- 3:2009/A1:201	DEKRA: 71- 107724



14	TABLE: list of critical components				P
object/part No.	manufacturer/ trademark	type/model	technical data	standard	mark(s) of conformity ¹⁾
				2 EN60947-3:2009/A2:2015	
	ProJoy Electric Co.,Ltd.	PEDS150(R)-HM25-2	1000Vdc 16Adc, Max. 85°C	EN60947-3:2009+A1+A3	TUV: R50417016
	MERZ Schaltgeräte GMBH + CO KG	MDC1A-025-600-2E-0178D-B25 V4	800Vdc 16Adc, Max. 75°C	EN 60947-1:2007+A1:2011 EN60947-3:2009	DEKRA: 2141205.01
	MERZ Schaltgeräte GMBH + CO KG	MDC10-040-1000-2E-0178U-D-B25	1000Vdc 20Adc, Max. 75°C	IEC60947-1:2007+AMD1:2010+AMD2:2014 IEC60947-3:2008+AMD1:2012+AMD2:2015	CQC: CN42078
Insulation sheet under IGBT	BERGQUIST CO	K-10#, 900S(#)	150°C, V-0, min. 0.18mm thickness.	UL 94	UL E59150
Plastic cover for fixing IGBT	NAN YA PLASTICS CORP PLASTICS 4TH DIV	1403G6	130°C, V-0, min. 1.5mm thickness.	UL 94	UL E130155
All PCB	All	All accepted	Min.130°C, min. V-0, CTI≥175	UL 796	UL
Mains power board					
Y-Capacitor (CP56, CP64)	Shantou High-New Technology Dev. Zone Songtian Enterprise Co., Ltd	CE	Max. 4700pF, Y2, min. 250Vac, 125°C	IEC 60384-14	VDE 40025754
	Jyh Chung Electronic Co., Ltd	JY	Max. 4700pF, Y2, 300Vac, 85°C	IEC 60384-14	VDE 123326
	Walsin Technology Corp.	AC	Max. 4700pF, Y2, min. 250Vac, 125°C	IEC 60384-14	VDE 40001829
Capacitor (CP61)	Wuxi chenrui New Energy technology CO., LTD	DMJ-PS20UF700V	20uF, 700Vdc, 85°C	--	--



14	TABLE: list of critical components				P
object/part No.	manufacturer/ trademark	type/model	technical data	standard	mark(s) of conformity ¹⁾
		EPB	20uF, 700Vdc, 85°C	--	--
BUS Capacitor (ECP1-ECP4) (For SOFAR 1100TL, SOFAR 1600TL: 2pcs; For SOFAR 2200TL, SOFAR 2700TL: 3pcs; For SOFAR 3000TL: 3 or 4 pcs;)	Nantong Jianghai Capacitor Co.,Ltd	ECS2HBB471ML A350060V	470uF, 500V, 105°C	--	--
	Nippon Chemi- Con Corporation	EKMM501VSN47 1MA60S	470uF, 500V, 105°C	--	--
	LELON ELECTRONICS CORP.	LSK471M2H-- A3555P	470uF, 500V, 105°C	--	--
	SAMXON	KP500V470uF	470uF, 500V, 105°C	--	--
Y-Capacitor (CP33)	Shantou High- New Technology Dev. Zone Songtian Enterprise Co., Ltd	CD	Max.4700pF, Y1, min. 250Vac, 125°C	IEC 60384-14	VDE 40025754
	Walsin Technology Corp.	AH	Max.4700pF, Y1, min. 250Vac, 125°C	IEC 60384-14	VDE 40001804
Y-Capacitor (CP1, CP5, CP7, CP13, CP55, CP63, CP75, CP78, CP83, CP85, CP96	Shantou High- New Technology Dev. Zone Songtian Enterprise Co., Ltd	CE	Max. 10000pF, Y2, min. 250Vac, 125°C	IEC 60384-14	VDE 40025754
	Jyh Chung Electronic Co., Ltd	JY	Max. 10000pF, Y2, 300Vac, 85°C	IEC 60384-14	VDE 123326
	Walsin Technology Corp.	AC	Max. 10000pF, Y2, min. 250Vac, 125°C	IEC 60384-14	VDE 40001829
Transformer (TP1)	HUIZHOU BAOHUI ELECTRONICS TECHNOLOGY CO.,LTD	SH-T007	130°C	--	--
	Bo Luo Da Xin Electronic Co.,Ltd				
Capacitor (CP79, CP81, CP100)	Shantou High- New Technology Dev. Zone Songtian Enterprise Co.,	MPX	2.2uF, 305Vac, 100°C, X2	IEC 60384-14	VDE 40034679



**BUREAU
VERITAS**

Test Report No: LD140508N005-R2

14	TABLE: list of critical components				P
object/part No.	manufacturer/ trademark	type/model	technical data	standard	mark(s) of conformity ¹⁾
	Ltd				
	XIAMEN FARATRONIC CO LTD	MKP62	2.2uF, 275Vac or 305Vac, 110°C, X2	EN60384-14	VDE 40000358
	Carli Electronics Co., Ltd.	MPX	2.2uF, min. 275Vac, 100°C, X2	EN60384-14	VDE 40008520
	EPCOS Electronic Components S.A.	B3292#	2.2uF, 305Vac, 105°C, X2	EN60384-14	VDE 40010694
Transformer (TXP1)	HUIZHOU BAOHUI ELECTRONICS TECHNOLOGY CO.,LTD Bo Luo Da Xin Electronic Co.,Ltd	SH-T008	110°C	--	--
- Winding	All	All accepted	130°C	UL 1446	UL
- Bobbin	SUMITOMO BAKELITE CO LTD CHANG CHUN PLASTICS CO LTD	PM-9820, PM-9030 T375J	V-0, min. thickness: 0.75mm, 150°C V-0, min. thickness: 0.75mm, 150°C	UL 94 UL 94	UL E41429 UL E59481
Diode (DP1)	Microsemi POWER PRODUCTS GROUP IXYS	APT30DQ60BG DSEI30-06A	600V, 30A, 175°C 600V, 37A, 150°C	-- --	-- --
X Capacitor (CP80, CP84)	Shantou High- New Technology Dev. Zone Songtian Enterprise Co., Ltd XIAMEN FARATRONIC CO LTD Carli Electronics Co., Ltd. EPCOS Electronic Components S.A.	MPX MKP62 MPX B3292#	1.0uF, 305Vac, 100°C, X2 1.0uF, 275Vac or 305Vac, 110°C, X2 1.0uF, min. 275Vac, 100°C, X2 1.0uF, 305Vac, 105°C, X2	IEC 60384-14 EN60384-14 EN60384-14 EN60384-14	VDE 40034679 VDE 40000358 VDE 40008520 VDE 40010694
Transistor (QP1, QP2, QP3, QP6, QP7)	FAIRCHILD SEMICONDUCTOR IOR	FGA40N65SMD IRGP4640D- EPbF	VCES : 650V, IC : 40A, 175°C VCES : 600V, IC : 40A, 175°C	-- --	-- --



14	TABLE: list of critical components				P
object/part No.	manufacturer/ trademark	type/model	technical data	standard	mark(s) of conformity ¹⁾
		IRGP4063DPBF	VCES : 600V, IC : 48A, 175°C	--	--
		IXXH40N65B4H1	VCES : 650V, IC110 : 40A, 175°C	--	--
Filter inductor (LP2, LP3, LP4)	HUIZHOU BAOHUI ELECTRONICS TECHNOLOGY CO., LTD.	SH-L014	1.3mH, 130°C	--	--
	Bo Luo Da Xin Electronic Co.,Ltd				
Thermo resistor		NTSA0103	10Kohm at 25°C	--	--
DSP (UC34, UC35)		TMS320F28034P NT	Supply voltage: 3.3V, ADC: 12-bit, 1xsci, 80 pin	--	--
GFCI Current sensor (LP5)	HUIZHOU BAOHUI ELECTRONICS TECHNOLOGY CO.,LTD	SH-T009	130°C	--	--
	Bo Luo Da Xin Electronic Co.,Ltd				
Plastic sheet under LP5	KINGBOARD LAMINATES HOLDINGS LTD	KB-6150 KB-5150	130°C, V-0, min. 1.4mm thickness.	UL 94	UL E123995
Varistor (RVP3, RVP4, RVP5, RVP6)	Shantou High- New Technology Dev. Zone Songtian Enterprise Co., Ltd	STE-14D681K	560VDC, I _{max} : 4.5KA, Max.: 85°C	IEC 61051-1 IEC 61051-2	VDE 40023049
	THINKING ELECTRONIC INDUSTRIAL CO., LTD	TVR14681	560VDC, I _{max} : 8KA, Max.: 85°C	IEC 61051-1 IEC 61051-2	VDE 40021243
Current sensor (HLP2)		CASR 15-NP	IPN: 15A; IOE: 53mA V _c : 5.25V _{max} . Max.: 85°C	--	--
		F02P015S05	I _f : 15A; I _{cc} : 30mA V _{cc} : 5.25V _{max} . Max.: 105°C	--	--
Relay (RYP2, RYP3, RYP4, RYP5)	Panasonic Corporation	ALFG2PF12	31A, 250Vac, 12Vdc, 85°C	VDE 0435	VDE 40023067
	Xiamen Hongfa	HF161F-W/12-	31A, 250Vac,	VDE 0435	VDE



14	TABLE: list of critical components				P
object/part No.	manufacturer/ trademark	type/model	technical data	standard	mark(s) of conformity ¹⁾
	Electroacoustics Co., Ltd.	HT	12Vdc, 85°C		40031410
Communication board					
Optocoupler (UC6-UC11)	Lite-On Technology Corporation	LTV-816	Di ≥ 0.4mm Internall di ≥ 7.0mm External di ≥ 7.62mm, AC 8000V, reinforced Insulation 115°C	DIN EN 60747-5-2	VDE 40015248
	Fairchild Semiconductor Pte Ltd	FOD817	Di ≥ 0.4mm Internall di ≥ 7.0mm External di ≥ 7.62mm, AC 6000V, reinforced Insulation 110°C	DIN EN 60747-5-2	VDE 40026857
	Everlight Electronics Co., Ltd.	EL817	Di ≥ 0.4mm Internall di ≥ 7.52mm External di ≥ 7.6mm, AC 6000V, reinforced Insulation 110°C	DIN EN 60747-5-2	VDE 132249
¹⁾ an asterisk indicates a mark which assures the agreed level of surveillance					



Appendix 1

4.8.2	TABLE: Array insulation resistance detection for inverters for ungrounded and functionally grounded arrays			P
4.8.2.1	Array insulation resistance detection for inverters for ungrounded arrays			P
DC Voltage below minimum operating voltage (V)	DC Voltage for inverter begin operation (V)	Resistance between ground and PV input terminal (Ω)	Required Insulation resistance $R = (V_{MAX\ PV} / 30mA)$ (Ω)	Result
DC+				
80	90	600K	16.67K	PV inverter can not start up, error message: ID56. (ISO fault)
80	230	600K	16.67K	
80	450	600K	16.67K	
80	500	600K	16.67K	
DC-				
80	90	600K	16.67K	PV inverter can not start up, error message: ID56. (ISO fault)
80	230	600K	16.67K	
80	450	600K	16.67K	
80	500	600K	16.67K	



Appendix 2

4.8.3 Array residual current detection		P
Test conditions:	Output power: 100% V_{DC} : 450V Frequency: 50Hz Current measuring devices: min. class 0,5 Time measuring devices: <10% of the measured value	

4.8.3.1 Test for correct disconnection in case of a steady rising residual current				P
+ PV to N:				
	Fault Current (mA)			
Limit (mA)	$0.85U_N$	U_N	$1.10U_N$	
<=300	230	227	230	
<=300	231	230	228	
<=300	230	230	239	
<=300	229	229	230	
<=300	231	229	231	
- PV to N:				
	Fault Current (mA)			
Limit (mA)	$0.85U_N$	U_N	$1.10U_N$	
<=300	229	232	230	
<=300	232	231	231	
<=300	230	231	233	
<=300	228	231	227	
<=300	228	230	230	
Note: Comparing test circuit at figure 21. Fault current will rise up to 300mA within 30s. 5 values will be measured and listed.				



4.8.3.5.2 Test for detection of excessive continuous residual current >300mA				P
+ PV to N:				
Fault Current > 300mA				
Limit (ms)	0.85U _N	U _N	1.10U _N	
300	283	270	280	
300	257	273	280	
300	284	256	255	
300	259	259	267	
300	253	254	278	
- PV to N:				
Fault Current > 300mA				
Limit (ms)	0.85U _N	U _N	1.10U _N	
300	252	253	259	
300	263	269	261	
300	252	267	241	
300	254	263	266	
300	256	275	268	
Note:				



4.8.3.5.3 Test for detection of sudden changes in residual current				P
+PV to N				
Limit (mA)	Fault Current (mA) / Time until unit switched off (s)			Limit (s)
	0.85U _N	U _N	1.10U _N	
	Disconnection time (ms)	Disconnection time (ms)	Disconnection time (ms)	
30	218	197	210	0.3
30	213	232	210	0.3
30	212	219	204	0.3
30	208	216	218	0.3
30	205	208	203	0.3
60	107	110	105	0.15
60	107	104	114	0.15
60	107	104	114	0.15
60	101	117	113	0.15
60	123	107	104	0.15
150	25	24	26	0.04
150	37	39	39	0.04
150	34	38	38	0.04
150	24	34	35	0.04
150	37	31	28	0.04



-PV to N				
Limit (mA)	Fault Current (mA) / Time until unit switched off (s)			Limit (s)
	0.85U _N	U _N	1.10U _N	
	Disconnection time (ms)	Disconnection time (ms)	Disconnection time (ms)	
30	203	217	218	0.3
30	219	204	220	0.3
30	222	226	231	0.3
30	210	223	216	0.3
30	201	225	216	0.3
60	127	124	110	0.15
60	112	111	116	0.15
60	120	103	104	0.15
60	100	96	109	0.15
60	105	102	105	0.15
150	28	38	36	0.04
150	25	37	36	0.04
150	34	31	26	0.04
150	37	27	32	0.04
150	26	34	29	0.04

Note:
 The capacitive current is risen until disconnection.
 Test condition: $I_c + 30/60/150mA \leq I_{cmax}$. R₁ is set that 30/6+0/150ma Flow and switch is closed.



**BUREAU
VERITAS**

Test Report No: LD140508N005-R2

Enclosure front view:



Enclosure rear view:





**BUREAU
VERITAS**

Test Report No: LD140508N005-R2

Enclosure terminal view:



Internal view-1

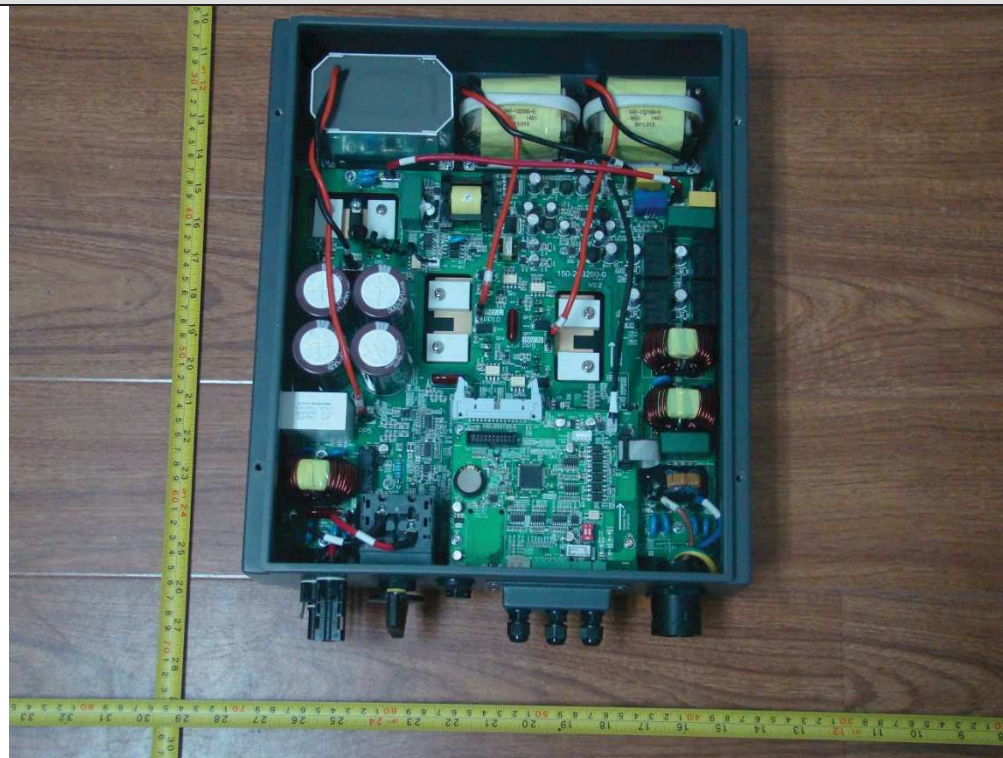



Internal view-2



Internal view-3

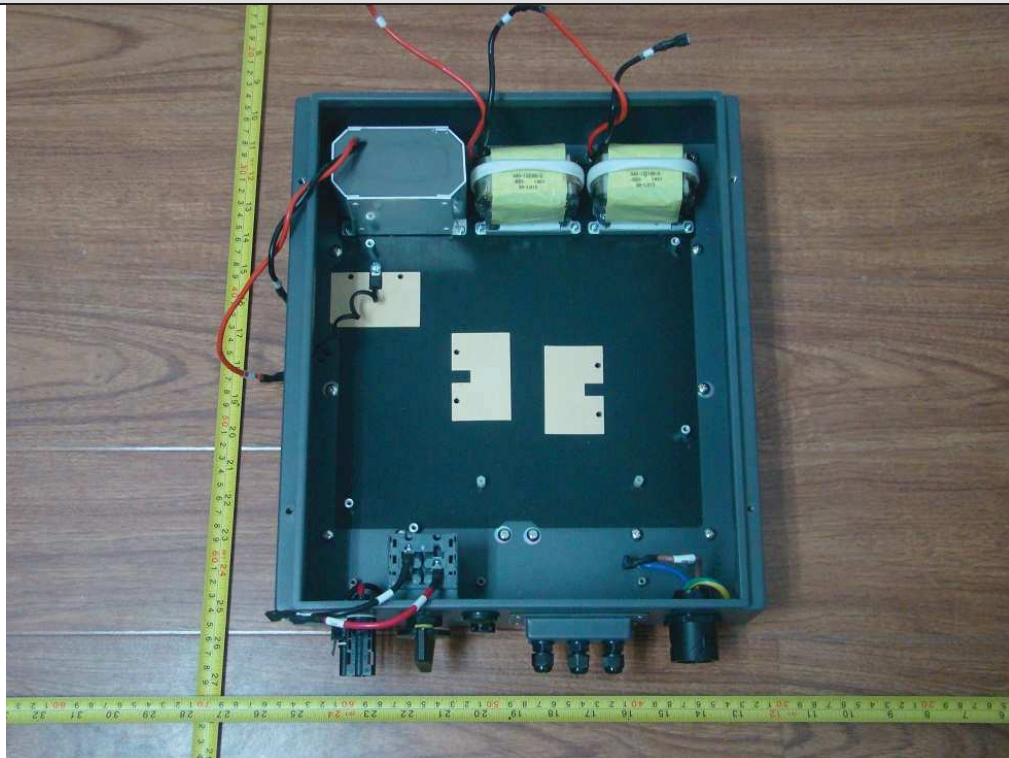



Internal view-4



Main power board component side view





Main power board solder side view

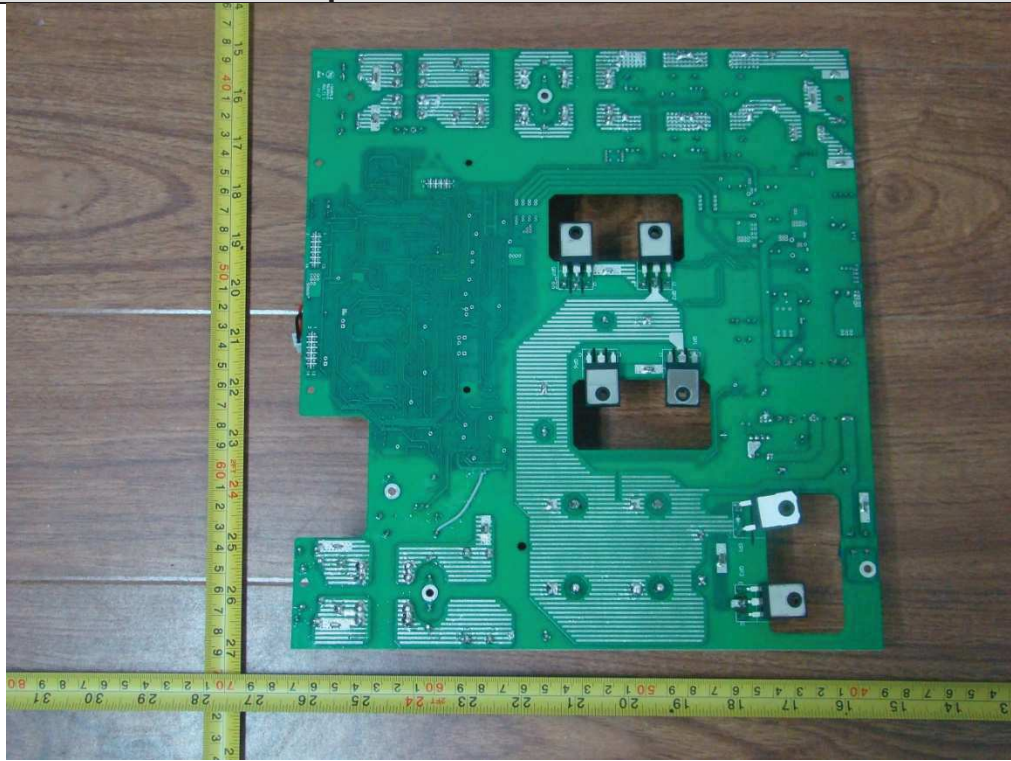

Control board component side view

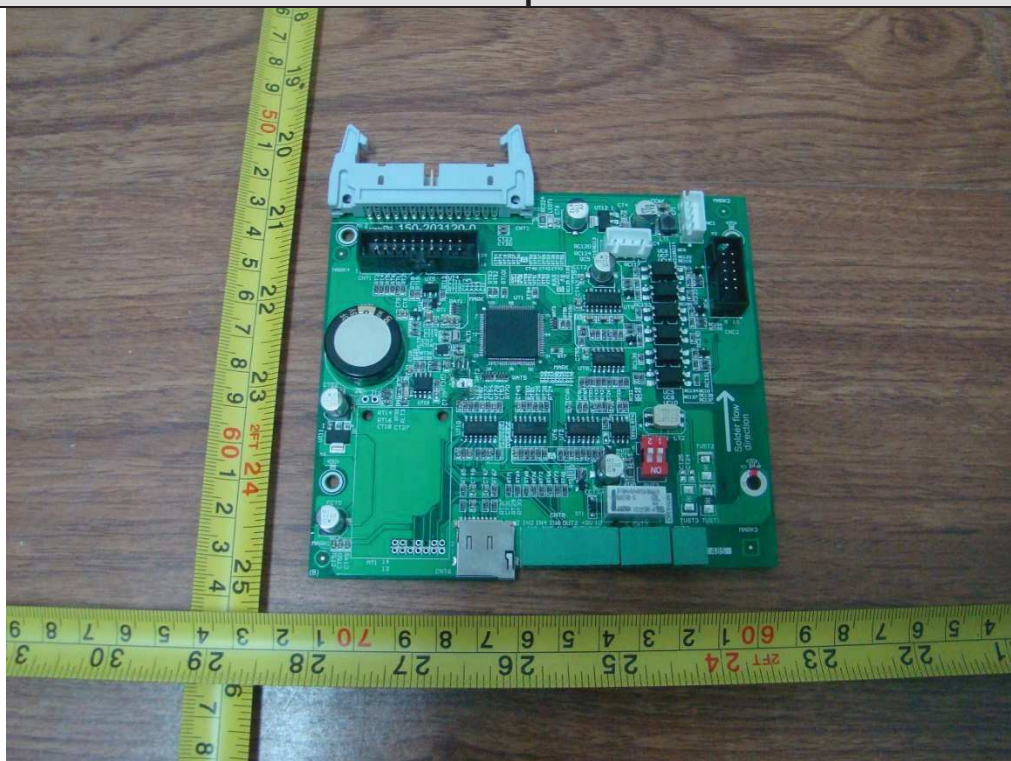



Control board solder side view

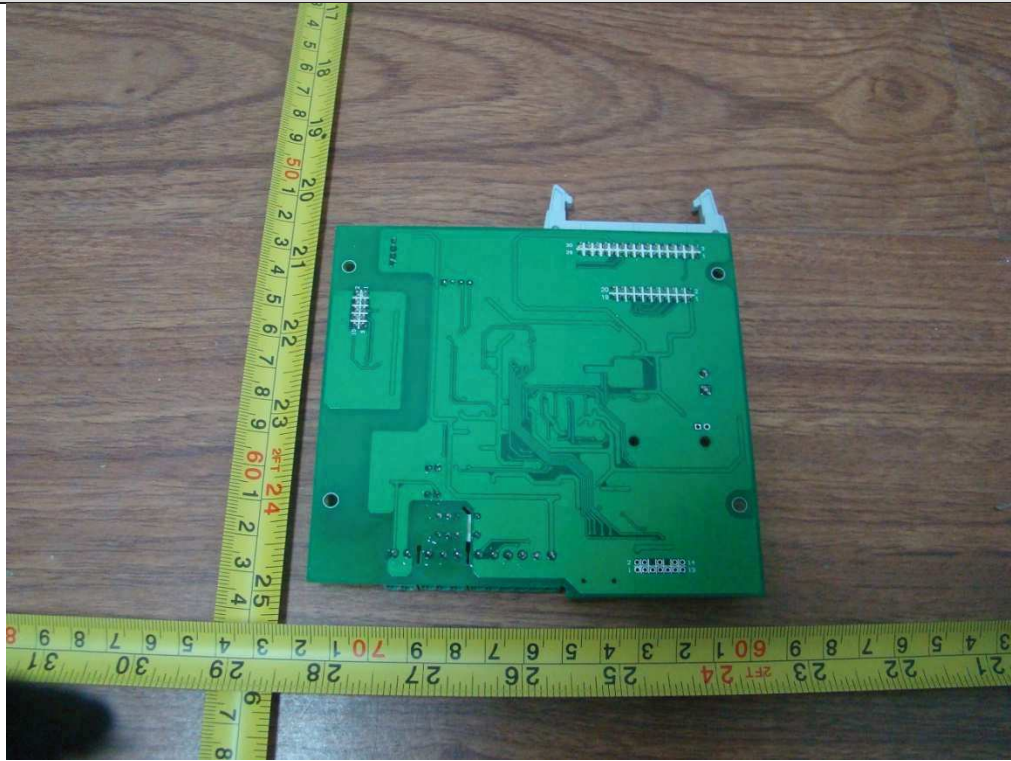

Display board component side view

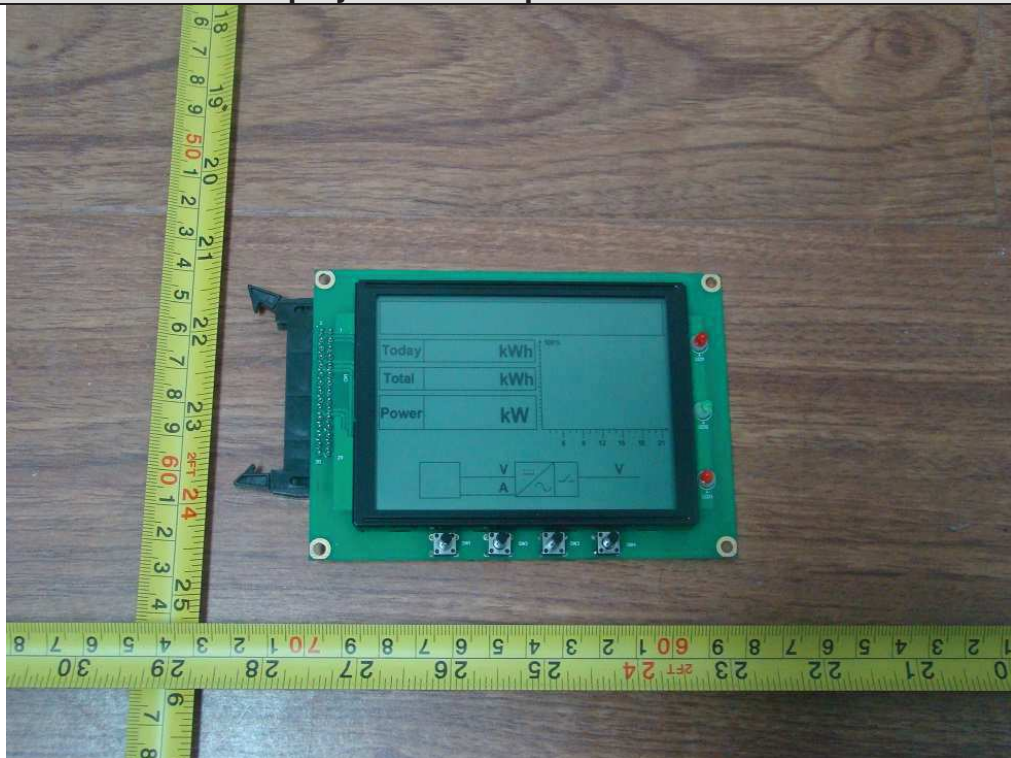



Display board solder side view

